

Electric Motovibrators MVE-Type

Good Vibrations
*When you need it
Where you need it*

MVE

Standard Range

2 poles	2-3
4 poles	4-5
6 poles	6-7
8 poles	8-9
2 poles single phase	10-11
Micro MVE	12-13
DC	14-15

MVE - E

Increased Safety Range

2 poles	16-17
4 poles	18-19
6 poles	20-21
8 poles	22-23

MVE - D

Explosion Proof Range

2 poles	24-25
4 poles	26-27
6 poles	28-29
8 poles	30-31

MVE - S

with Split Cover

4 poles	32-33
6 poles	34-35
8 poles	36-37

- FRAME:**
Aluminium frame from size 10 to 50 and ductile cast iron from size 60 to 90
- TERMINAL PLATE:**
M5 from size 10 to 50 and M6 from size 60 to 90
- CABLE GLANDS:**
Plastic M16 and M20 from size 10 to 50 and metal M25 and M32 from size 60 to 90
- FLANGE:**
Gray cast iron from size 10 to 90
- WINDINGS:**
2,4,6 and 8 poles three-phase asynchronous motor from size 10 to 90;
2 poles single phase from size 10 to 30.
All motors are vacuum impregnated (VPI SYSTEM); PTC thermistors 130°C standard from size 60; Class F (155°C); continuous service (S1);
- SHAFT:**
Steel alloy high resistant to stress; PTC thermistors 130°C standard from size 60
- ECCENTRIC WEIGHTS:**
Completely adjustable; the scale express the centrifugal force as a percentage of the maximum centrifugal force.
- BEARING:**
Ball bearing from size 10 to 50 and roller bearing from size 50 (for some types only) to 90 (C3 clearance)
- COVER**
Aluminium alloy from size 10 to 50 and steel from size 60 to 90.
Stainless steel AISI 304 for direct current motovibrators.
For explosion proof range, all the covers are made of stainless steel.
- SURFACE TREATMENT**
Polyester epoxy powder painting.
Standard colour RAL 2004.

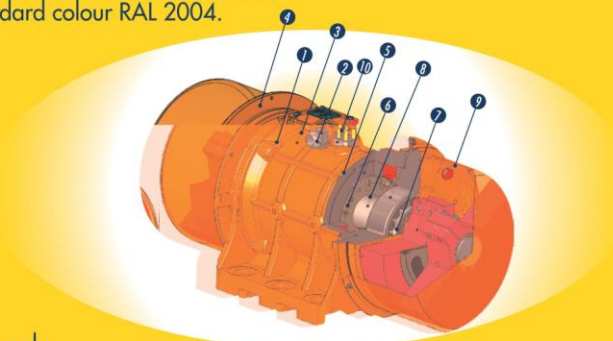

Power supply

- Three-phase from 12V to 690V, 50Hz or 60Hz;
- Single phase 110V 60Hz and 220V 50Hz.
- All motors are designed for inverter application from 20Hz to base frequency

Conformity with European Directive

- Low voltage 2006/95/EC
- EMC 2004/108/EC
- Machine directive 2006/42/EC
- ATEX 94/9/EC

Mechanical protection IP66 according to EN 60529

MVE - Standard Range

▶ 2 POLES

3000 - 3600 rpm



- II 3 D Ex tD A22 Tx IP66
- TUV NORD Statement Conformity Number TUV 05 ATEX 2768X
- Equipment and protective system intended for use in potentially explosive atmospheres (Zone 22) - Directive 94/9/EC
- Compliance with Essential Health and Safety Requirements
- EN 61241-10

TYPE	Mechanical Features						Electric Features								
	Working moment (*)		FC		Weight		Power		Current		Ia/In		ⓉD	ⓂEx	Cable Glande
	Kgcm		Kg		Kg		Kw		A max (Y)				Class II Div.2	II 3 D	
	50Hz	60Hz	50Hz	60Hz	50Hz	60Hz	50 Hz	60 Hz	50 Hz	60 Hz	50Hz	60Hz	Temp. Class	Temp. Class	
								400V	460V			(T)	(°C)		
MVE 60/3	1.31	0.98	66	71	4.2		0.08	0.09	0.16	0.18	3.0	3.0	T4	100	M16
MVE 100/3	1.96	1.31	98	95	4.6		0.1	0.11	0.19	0.18	3.0	3.0		100	M16
MVE 200/3	3.72	2.61	187	189	7.0		0.18	0.21	0.35	0.35	3.3	3.30	T4	100	M20
MVE 202/3	3.72	2.61	187	189	7.2		0.18	0.21	0.35	0.35	3.3	3.30	T4	100	M20
MVE 300/3	6.39	4.46	321	323	9.8		0.27	0.28	0.52	0.45	3.60	3.50	T4	100	M20
MVE 400/3	7.96	5.68	407	411	10.3		0.30	0.36	0.58	0.60	3.50	3.50		100	M20
MVE 500/3	10.27	7.38	530	534	15.8		0.50	0.58	0.96	0.97	4.00	4.20	T4	100	M20
MVE 700/3	14.90	10.57	758	765	16.5		0.66	0.75	1.25	1.24	4.30	5.00		100	M20
MVE 800/3	15.68	11.06	794	800	20.6		0.75	0.90	1.45	1.50	3.80	3.80		100	M20
MVE 1200/3	20.26	14.00	1005	1013	21.6		0.95	1.15	1.85	1.95	4.40	4.50	T4	100	M20
MVE 1300/3	26.58	18.60	1355	1365	22.0		1.30	1.38	2.44	2.25	5.20	5.00		100	M20
MVE 1301/3	26.58	18.60	1355	1365	34		1.30	1.38	2.44	2.25	5.20	5.00	T4	100	M20
MVE 1310/3	22.34	22.34	1123	1616	34		1.30	1.38	2.44	2.25	5.20	5.00	T4	100	M20
MVE 1600/3	31.26	22.22	1601	1608	51.6	51.2	1.57	1.60	2.94	2.61	5.90	6.20		135	M25
MVE 2000/3	36.78	27.60	2027	1997	52.8	52.0	2.00	2.10	3.75	3.42	6.50	6.40	T4	135	M25
MVE 2300/3	45.97	31.87	2302	2306	53.6	51.6	2.40	2.45	4.44	3.94	6.00	6.30		135	M25
MVE 3200/3	68.10	43.89	3252	3176	103.0	101.4	2.90	2.90	5.30	4.61	8.30	8.20		135	M32
MVE 4000/3	79.40	55.99	4033	4052	107.0	103.8	2.90	2.90	5.30	4.61	8,5	9,7	T4	135	M32
MVE 5000/3	103.24	69.76	5009	5048	111.2	105.8	4.00	4.00	7.22	6.28	8.50	9.80		135	M32

TYPE	Mechanical Features						Electric Features								
	Working moment (*)		FC		Weight		Power		Current		Ia/In		ⓉD	ⓂEx	Cable Glande
	Kgcm		Kg		Kg		Kw		A max (Δ)				Class II Div.2	II 3 D	
	50Hz	60Hz	50Hz	60Hz	50Hz	60Hz	50 Hz	60 Hz	50 Hz	60 Hz	50Hz	60Hz	Temp. Class	Temp. Class	
								400V	460V			(T)	(°C)		
MVE 6500/3	129.55	90.54	6510	6552	228.4	229.6	5.50	5.50	9.5	8	4.20	5.30	T4	135	M32
MVE 9000/3	179.59	129.55	9025	9375	240.3	234.7	10.00	9.30	14.00	18.00	5.00	5.00		135	M32

(*) = Working moment = 2 x static moment

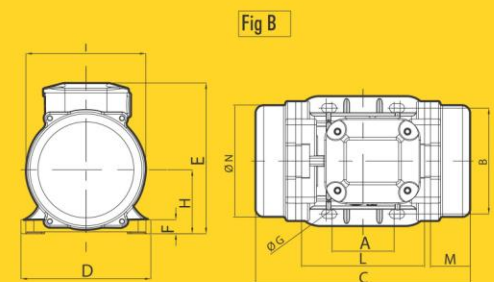
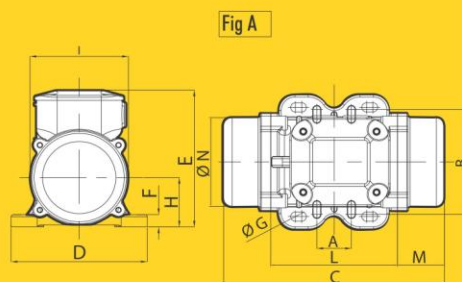
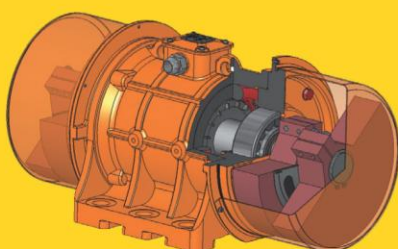

CE Declaration of conformity "type B" according to:
- 2006/95/EC - 2004/108/EC - 2006/42/EC - EN 60034-1

Intertek
- Class II Div.2 Group F, G - T4 - NEMA 4
- Conform to UL 1836, UL1004 Cert. CSA C22.2 N°25,100,145
- Intertek ETL - SEMCO File Number 3177001



TYPE	Dimensional Features																
	FIG.	Size	C (mm)		M (mm)		A (mm)	B (mm)	Ø G (mm)	Holes (n°)	D (mm)	E (mm)	F (mm)	H (mm)	I (mm)	L (mm)	N (mm)
			50Hz	60Hz	50Hz	60Hz											
MVE 60/3	A	10	211		45	*	*	*	4	130	136	12	48	94	121	85	
MVE 100/3	A	10	211		45	*	*	*	4	130	136	12	48	94	121	85	
MVE 200/3	B	20	231		54	62-74	106	9	4	131	159	15	64	121	123	112	
MVE 202/3	G	23	218		53	**	**	**	4	164	140	25	82	116	159	110	
MVE 300/3	C	30	253		45	***	***	***	4	154	175	15	79	142	163	131	
MVE 400/3	C	30	273		55	***	***	***	4	154	175	15	79	142	163	131	
MVE 500/3	D	40	334		78	105	140	13	4	168	196	22	92	169	178	158	
MVE 700/3	D	40	334		78	105	140	13	4	168	196	22	92	169	178	158	
MVE 800/3	D	50	321		58	120	170	17	4	208	210	22	94	180	205	170	
MVE 1200/3	D	50	321		58	120	170	17	4	208	210	22	94	180	205	170	
MVE 1300/3	D	50	321		58	120	170	17	4	208	210	22	94	180	205	170	
MVE 1301/3	D	53	321		58	100	180	17	4	236	210	26	98	180	205	170	
MVE 1310/3	D	55	321		58	100	200	17	4	236	210	26	98	180	205	170	
MVE 1600/3	D	60	418		83	140	190	17	4	229	247	30	120	247	220	222	
MVE 2000/3	D	60	418		83	140	190	17	4	229	247	30	120	247	220	222	
MVE 2300/3	D	60	418		83	140	190	17	4	229	247	30	120	247	220	222	
MVE 3200/3	D	75	538		115	155	255	25	4	302	318	35	147	295	273	264	
MVE 4000/3	D	75	538		115	155	255	25	4	302	318	35	147	295	273	264	
MVE 5000/3	D	75	588	538	140	115	155	255	25	4	302	318	35	147	295	273	264

TYPE	Dimensional Features																
	FIG.	Size	C (mm)		M (mm)		A (mm)	B (mm)	Ø G (mm)	Holes (n°)	D (mm)	E (mm)	F (mm)	H (mm)	I (mm)	L (mm)	N (mm)
			50Hz	60Hz	50Hz	60Hz											
MVE 6500/3	D	85	605		120	200	320	28	4	385	410	49	199	421	325	378	
MVE 9000/3	D	85	605		120	200	320	28	4	385	410	49	199	421	325	378	

Fig A

	A (mm)	B (mm)	Ø G (mm)
*	62 - 74	106	9
	33	83-102	7

Fig G

	A (mm)	B (mm)	Ø G (mm)
**	62 - 74	106	9
	65	140	13
	115	135	11
	135	115	11

Fig C

	A (mm)	B (mm)	Ø G (mm)
***	80	110	11
	90	125	13
	124	110	11
	135	115	11

NOTE: Dimensions with coarse degree of accuracy related to UNI 22768/1

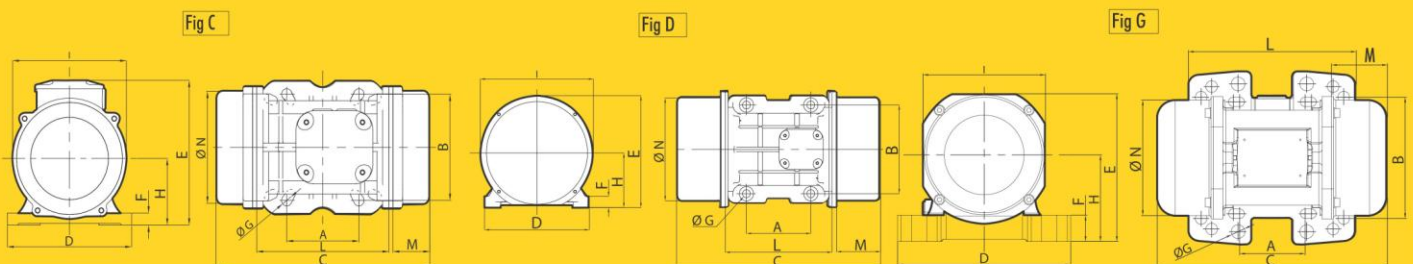

MVE - Standard Range

▶ 4 POLES

1500 - 1800 rpm



- II 3 D Ex tD A22 Tx IP66
- TUV NORD Statement Conformity Number TUV 05 ATEX 2768X
- Equipment and protective system intended for use in potentially explosive atmospheres (Zone 22) - Directive 94/9/EC
- Compliance with Essential Health and Safety Requirements - EN 61241-10

TYPE	Mechanical Features						Electric Features								
	Working moment (*)		FC		Weight		Power		Current		Ia/In		Class II Div.2	Ex	Cable
	Kgcm		Kg		Kg		Kw		A max (Y)				Temp. Class	Temp. Class	
	50Hz	60Hz	50Hz	60Hz	50Hz	60Hz	50 Hz	60 Hz	50 Hz	60 Hz	50Hz	60Hz	(T)	(°C)	Glande
MVE 40/15	1.97	1.97	25	36	4.6		0.04	0.05	0.31	0.31	2.00	2.00	T4	100	M16
MVE 90/15	5.97	4.2	75	76	7.4		0.09	0.1	0.26	0.25	2.00	2.00	T4	100	M20
MVE 200/15	15.44	10.83	194	196	11.8		0.16	0.17	0.49	0.50	2.00	2.00	T4	100	M20
MVE 400/15	33.43	23.38	420	423	19.5		0.30	0.35	0.84	0.86	2.50	2.50	T4	100	M20
MVE 500/15	40.12	28.08	504	508	21.0		0.35	0.40	1.06	1.09	2.80	2.70		100	M20
MVE 300/15	26.58	18.60	334	336	22.5		0.62	0.73	1.32	1.41	3.00	3.20	T4	100	M20
MVE 700/15	56.83	39.36	714	712	27.4		0.62	0.73	1.32	1.41	3.00	3.20		100	M20
MVE 1100/15	88.67	62.02	1114	1122	35.8		0.65	0.78	1.50	1.70	3.80	3.80	T4	100	M20
MVE 1400/15	108.57	76.72	1364	1388	59.8	58.2	0.90	1.10	1.71	1.78	4.00	4.00		135	M25
MVE 1700/15	137.31	91.98	1725	1664	61.8	59.4	1.15	1.30	2.16	2.09	4.70	4.50	T4	135	M25
MVE 2400/15	187.69	137.36	2358	2485	68.0	62.0	1.60	1.90	3.00	3.20	4.90	4.90		135	M25
MVE 2500/15	203.53	135.65	2557	2454	90.0	84.0	1.80	2.00	3.40	3.40	6.00	6.10	T4	135	M25
MVE 3000/15	248.66	169.75	3124	3071	97.5	87.0	1.90	2.30	3.70	3.80	6.50	6.60		135	M25
MVE 3800/15	306.69	204.74	3853	3704	130.4	118.4	2.20	2.60	4.12	4.15	6.80	6.80	T4	135	M32
MVE 4300/15	343.22	240.95	4312	4359	134.4	123.6	2.50	3.00	5.70	5.80	7.00	7.20		135	M32
MVE 5500/15	437.39	303.74	5495	5495	192.2	190.0	3.60	3.45	6.50	6.60	7.10	7.00	T4	135	M32

TYPE	Mechanical Features						Electric Features								
	Working moment (*)		FC		Weight		Power		Current		Ia/In		Class II Div.2	Ex	Cable
	Kgcm		Kg		Kg		Kw		A max (Δ)				Temp. Class	Temp. Class	
	50Hz	60Hz	50Hz	60Hz	50Hz	60Hz	50 Hz	60 Hz	50 Hz	60 Hz	50Hz	60Hz	(T)	(°C)	Glande
MVE 7200/15	576.76	397.32	7246	7188	253.0	246.6	5.00	6.00	9.60	9.41	6.80	6.90	T4	135	M32
MVE 9000/15	717.97	498.76	9020	9023	268.6	257.8	7.50	8.50	12.00	12.00	7.00	7.00		135	M32
MVE 10000/15	800.11	588.30	10052	10643	311.8	297.4	7.80	9.40	13.00	13.00	6.50	6.40	T4	135	M32
MVE 11500/15	932.2	655.4	11779	11853	445	422	10	10.5	17.50	15.50	7	7	/	135	M32
MVE 14500/15	1142.4	837.6	14352	15153	460	442	11	12	20	20	8	8	/	135	M32

(*) = Working moment = 2 x static moment

Fig A

Fig B

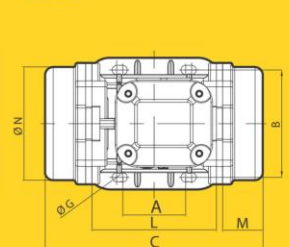
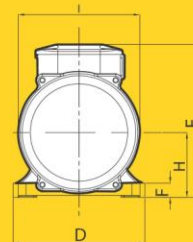
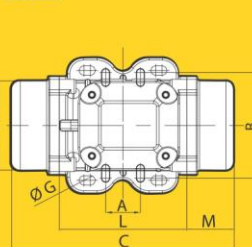
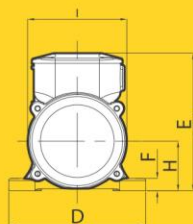
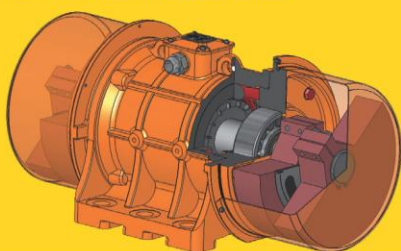

CE Declaration of conformity "type B" according to:
- 2006/95/EC - 2004/108/EC - 2006/42/EC - EN 60034-1

Intertek
- Class II Div.2 Group F, G - T4 - NEMA 4
- Conform to UL 1836, UL1004 Cert. CSA C22.2 N°25,100,145
- Intertek ETL - SEMCO File Number 3177001



TYPE	Dimensional Features																
	FIG.	Size	C (mm)		M (mm)		A (mm)	B (mm)	Ø G (mm)	Holes n°	D (mm)	E (mm)	F (mm)	H (mm)	I (mm)	L (mm)	N (mm)
			50Hz	60Hz	50Hz	60Hz											
MVE 40/15	A	10	211		45		*	*	*	4	130	136	12	48	94	121	85
MVE 90/15	B	20	231		54		62-74	106	9	4	131	159	15	64	121	123	112
MVE 200/15	C	30	273		55		***	***	***	4	154	175	15	79	142	163	131
MVE 400/15	D	40	334		78		105	140	13	4	168	196	22	92	169	178	158
MVE 500/15	D	40	334		78		105	140	13	4	168	196	22	92	169	178	158
MVE 300/15	D	50	321		58		120	170	17	4	208	210	22	94	180	205	170
MVE 700/15	D	50	391		93		120	170	17	4	208	210	22	94	180	205	170
MVE 1100/15	D	50	451		123		120	170	17	4	208	210	22	94	180	205	170
MVE 1400/15	D	60	446		96		140	190	17	4	229	247	30	120	247	220	222
MVE 1700/15	D	60	446		96		140	190	17	4	229	247	30	120	247	220	222
MVE 2400/15	D	60	510	446	129	96	140	190	17	4	229	247	30	120	247	220	222
MVE 2500/15	D	70	522	486	123	105	155	225	22	4	272	284	40	140	267	250	235
MVE 3000/15	D	70	556	486	123	105	155	225	22	4	272	284	40	140	267	250	235
MVE 3800/15	D	75	588	538	140	115	155	255	23.5	4	302	318	35	147	295	273	264
MVE 4300/15	D	75	588		140		155	255	23.5	4	302	318	35	147	295	273	264
MVE 5500/15	D	80	603		130		180	280	26	4	332	360	37	167	345	304	310

TYPE	Dimensional Features																
	FIG.	Size	C (mm)		M (mm)		A (mm)	B (mm)	Ø G (mm)	Holes n°	D (mm)	E (mm)	F (mm)	H (mm)	I (mm)	L (mm)	N (mm)
			50Hz	60Hz	50Hz	60Hz											
MVE 7200/15	D	85	605		120		200	320	28	4	385	410	49	200	422	325	378
MVE 9000/15	D	85	605		120		200	320	28	4	385	410	49	200	422	325	378
MVE 10000/15	E	90	726	646	160	120	125	380	38	6	452	430	44	204	422	367	378
MVE 11500/15	E	100	890		210		140	440	45	6	530	484	37	232	446	470	424
MVE 14500/15	E	100	890		210		140	440	45	6	530	484	37	232	446	470	424

Fig A

A (mm)	B (mm)	Ø G (mm)
62-74	106	9
33	83-102	7

Fig C

A (mm)	B (mm)	Ø G (mm)
80	110	11
90	125	13
124	110	11
135	115	11

NOTE: Dimensions with coarse degree of accuracy related to UNI 22768/1

Fig C

Fig D

Fig E

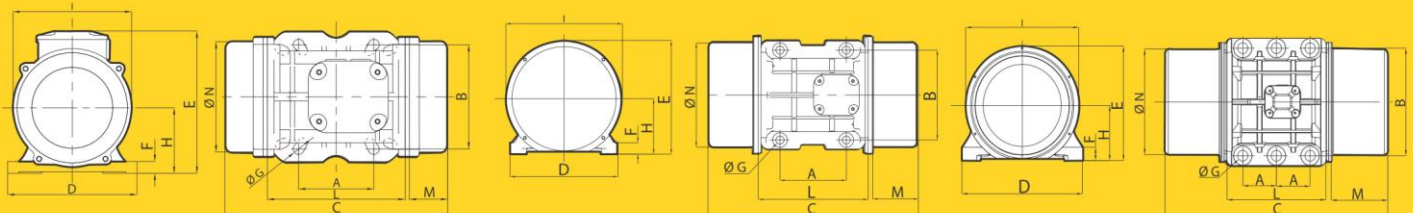

MVE - Standard Range

▶ 6 POLES

1000 - 1200 rpm



- II 3 D Ex tD A22 Tx IP66
- TUV NORD Statement Conformity Number TUV 05 ATEX 2768X
- Equipment and protective system intended for use in potentially explosive atmospheres (Zone 22) - Directive 94/9/EC
- Compliance with Essential Health and Safety Requirements - EN 61241-10

TYPE	Mechanical Features						Electric Features								Class II Div.2 Temp. Class (T)	II 3 D Temp. Class (°C)	Cable Glande
	Working moment (*)		FC		Weight		Power		Current		Ia/In						
	Kgcm		Kg		Kg		50 Hz	60 Hz	A max (Y)		50Hz	60Hz					
	50Hz	60Hz	50Hz	60Hz	50Hz	60Hz	50 Hz	60 Hz	50 Hz	60 Hz	400V	460V					
MVE 50/1	9.49	6.59	53	53	10.4		0.12	0.14	0.40	0.40	2.00	2.00	T4	100	M20		
MVE 100/1	18.80	13.18	105	106	12.2		0.12	0.14	0.40	0.40	2.00	2.00		100	M20		
MVE 200/1	33.49	23.38	187	188	19.6		0.18	0.21	0.53	0.51	2.00	2.00		T4	100	M20	
MVE 300/1	56.93	39.85	318	320	26.6		0.35	0.38	0.67	0.64	2.50	2.50	T4	100	M20		
MVE 500/1	91.88	64.32	513	517	34.0		0.35	0.40	1.20	1.15	2.80	2.70		100	M20		
MVE 510/1	91.88	91.88	513	739	34.5		0.35	0.40	1.20	1.15	2.80	2.70		100	M20		
MVE 800/1	137.37	108.58	767	873	61.8	59.4	0.68	0.76	1.29	1.26	2.80	2.80	T4	135	M25		
MVE 1100/1	187.69	137.31	1048	1104	79.4	73.0	0.75	0.80	1.42	1.32	3.20	3.10		135	M25		
MVE 1500/1	284.76	196.51	1590	1580	83.6	76.5	1.10	1.30	2.10	2.00	3.30	3.30		135	M25		
MVE 1600/1	299.63	203.47	1673	1636	99.8	89.0	1.10	1.30	2.83	3.22	3.70	3.60	T4	135	M25		
MVE 2100/1	373.05	248.74	2083	2000	114.3	100.5	1.50	1.80	3.00	3.00	4.30	4.40		135	M25		
MVE 2600/1	467.44	306.70	2610	2466	148.6	131.5	1.96	2.10	3.63	3.38	4.80	4.80		T4	135	M32	
MVE 3000/1	540.33	379.71	3017	3053	155.4	137.8	2.20	2.40	4.50	4.30	5.00	5.00	135		M32		
MVE 5210/1	939.60	657.90	5237	5290	225	191	3.80	4	6.92	6.36	5.50	5.50	T4		135	M25	
MVE 3800/1	680.38	437.41	3799	3517	215.6	194.8	2.50	3.00	4.67	4.88	5.90	6.00	T4	135	M32		
MVE 4700/1	838.34	584.17	4681	4697	230.8	212.4	3.20	3.90	6.50	6.00	5.50	5.70		135	M32		
MVE 5200/1	929.86	654.57	5192	5263	279.8	264.2	3.80	4.00	6.92	6.36	5.50	5.50		T4	135	M32	
MVE 6500/1	1165.19	823.96	6506	6625	304.4	280.7	4.30	5.00	7.76	7.81	6.20	6.00	135		M32		
TYPE	Working moment (*) (Kgcm)		FC (Kg)		Weight (Kg)		Power (Kw)		Current A max (Δ)		Ia/In		Class II Div.2 Temp. Class (T)		II 3 D Temp. Class (°C)	Cable Glande	
	50Hz	60Hz	50Hz	60Hz	50Hz	60Hz	50Hz	60Hz	50Hz/400v	60Hz/460V	50Hz	60Hz					
MVE 8000/1	1435.98	929.80	8018	7476	325.2	290	7.10	7.50	12.60	11.60	6.00	6.20	T4	135	M32		
MVE 9000/1	1600.39	1165.23	8936	9369	337.8	307.6	7.50	8.30	13.20	12.60	6.30	6.20		135	M32		
MVE 10000/1	1788.44	1239.98	9986	9970	385.8	359.3	7.60	8.00	13.50	12.70	6.40	6.40		T4	135	M32	
MVE 13000/1	2329.84	1647.42	13009	13246	422.2	375.6	10.00	10.00	17.00	16.00	6.20	6.2	/	135	M32		
MVE 12000/1	2253	1550	12580	12466	522	476	9	9.5	16	15	5	5.5		135	M32		
MVE 15000/1	2634	1856	14706	14923	672	630	10.5	11	19	18	5.5	5.8		135	M32		
MVE 17500/1	3220	2147	17980	17264	744	684	13	13.5	24	23	5.6	5.9	/	135	M32		
MVE 19500/1	3632	/	20285	/	768	/	14	/	25	/	5.4	5.6	/	135	M32		
MVE 22000/1	4067	2622	22711	21079	916	868	18.5	18.5	32	26	4.8	5.3	/	135	M32		
MVE 25000/1	4572	/	25532	/	994	/	19	/	33	/	5	4.5	/	135	M32		

(*) = Working moment = 2 x static moment

Fig C

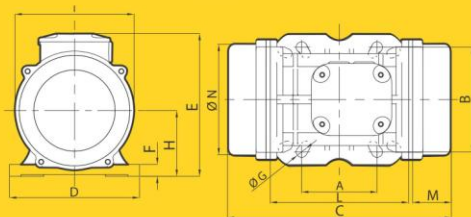
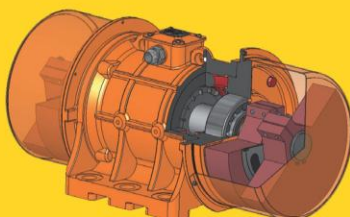
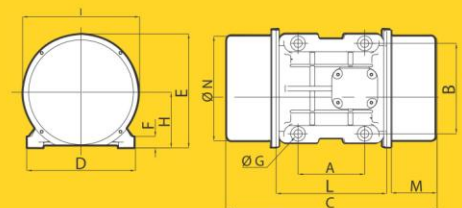

Fig D



CE Declaration of conformity "type B" according to:
- 2006/95/EC - 2004/108/EC - 2006/42/EC - EN 60034-1

Intertek
- Class II Div.2 Group F, G - T4 - NEMA 4
- Conform to UL 1836, UL1004 Cert. CSA C22.2 N°25,100,145
- Intertek ETL - SEMCO File Number 3177001



TYPE	Dimensional Features																
	FIG.	Size	C (mm)		M (mm)		A (mm)	B (mm)	Ø G (mm)	Holes n°	D (mm)	E (mm)	F (mm)	H (mm)	I (mm)	L (mm)	N (mm)
			50Hz	60Hz	50Hz	60Hz											
MVE 50/1	C	30	273		55		***	***	***	4	154	175	15	79	142	163	131
MVE 100/1	C	30	303		70		***	***	***	4	154	175	15	79	142	163	131
MVE 200/1	D	40	334		78		105	140	13	4	168	196	22	92	169	178	158
MVE 300/1	D	50	391		93		120	170	17	4	208	210	22	94	180	205	170
MVE 500/1	D	50	451		123		120	170	17	4	208	210	22	94	180	205	170
MVE 510/1	D	50	451		123		120	170	17	4	208	210	22	94	180	205	170
MVE 800/1	D	60	446		96		140	190	17	4	229	247	30	120	247	220	222
MVE 1100/1	D	60	510	446	129	96	140	190	17	4	229	247	30	120	247	220	222
MVE 1500/1	D	60	562	510	154	129	140	190	17	4	229	247	30	120	247	220	222
MVE 1600/1	D	70	556	522	140	123	155	225	22	4	272	284	40	140	267	250	235
MVE 2100/1	D	70	616	556	170	140	155	225	22	4	272	284	40	140	267	250	235
MVE 2600/1	D	75	708	588	200	140	155	255	23.5	4	302	318	35	147	295	273	264
MVE 3000/1	D	75	708	608	200	150	155	255	23.5	4	302	318	35	147	295	273	264
MVE 5210/1	E	78	794		242		105	248	22	6	300	335	30	163	305	310	284
MVE 3800/1	D	80	683	603	170	130	180	280	26	4	332	360	37	167	345	304	310
MVE 4700/1	D	80	733	683	195	170	180	280	26	4	332	360	37	167	345	304	310
MVE 5200/1	D	85	685	605	160	120	200	320	28	4	385	410	49	200	422	325	378
MVE 6500/1	D	85	685		160		200	320	28	4	385	410	49	200	422	325	378
TYPE	FIG.	Size	C (mm)		C (mm)		A (mm)	B (mm)	Ø G (mm)	Holes n°	D (mm)	E (mm)	F (mm)	H (mm)	I (mm)	L (mm)	N (mm)
			50Hz	60Hz	50Hz	60Hz											
MVE 8000/1	D	85	785	685	210	160	200	320	28	4	385	410	49	200	422	325	378
MVE 9000/1	D	85	785	685	210	160	200	320	28	4	385	410	49	200	422	325	378
MVE 10000/1	E	90	826		210		125	380	38	6	452	430	44	204	422	367	378
MVE 13000/1	E	90	926	826	260	210	125	380	38	6	452	430	44	204	422	367	378
MVE 12000/1	E	100	1020		275		140	440	45	6	530	484	37	232	446	470	424
MVE 15000/1	H	105	980		210		140	480	45	8	570	542	48	268	510	560	490
MVE 17500/1	H	105	1060		250		140	480	45	8	570	542	48	268	510	560	490
MVE 19500/1	H	105	1060		250		140	480	45	8	570	542	48	268	510	560	490
MVE 22000/1	H	110	1130		285		140	520	45	8	610	594	42	297	560	560	530
MVE 25000/1	H	110	1130		285		140	520	45	8	610	594	42	297	560	560	530

NOTE: Dimensions with coarse degree of accuracy related to UNI 22768/1

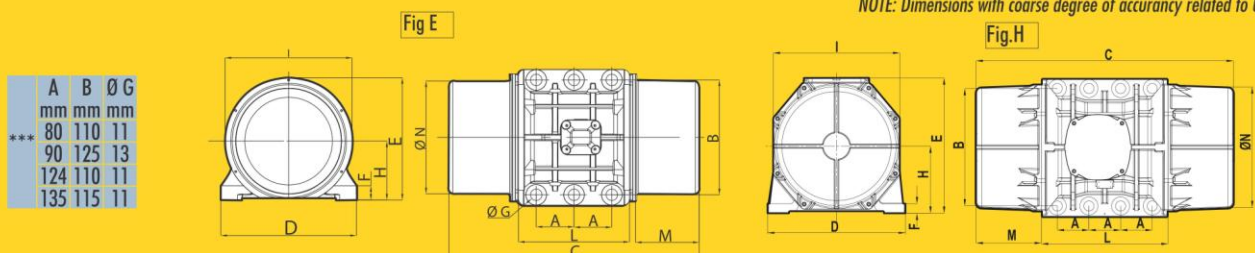

MVE - Standard Range

▶ 8 POLES

750 - 900 rpm



- II3 D Ex tD A22 Tx IP66
- TUV NORD Statement Conformity Number TUV 05 ATEX 2768X
- Equipment and protective system intended for use in potentially explosive atmospheres (Zone 22) - Directive 94/9/EC
- Compliance with Essential Health and Safety Requirements - EN 61241-10

TYPE	Mechanical Features					Electric Features								
	Working moment (*)		FC		Weight	Power		Current		Ia/In		Ⓜ	Ⓜ	Cable Glende
	Kgcm		Kg		Kg	Kw		A max (Y)				Class II Div.2	II3 D	
	50Hz	60Hz	50Hz	60Hz	50Hz - 60Hz	50 Hz	60 Hz	50 Hz	60 Hz	50Hz	60Hz	Temp. Class	Temp. Class	
							400V	460V			(T)	(°C)		
MVE 150/075	33.39		105	151	21.4	0.23	0.25	1.14	1.14	1.50	1.50	T4	100	M20
MVE 250/075	56.93		179	257	29.5	0.35	0.38	1.15	1.15	1.70	1.70	T4	100	M20
MVE 400/075	84.02		264	380	35.0	0.35	0.38	1.15	1.15	1.90	1.90	T4	100	M20
MVE 650/075	137.31		431	621	64.7	0.50	0.60	1.20	1.20	2.20	2.20	T4	135	M25
MVE 900/075	187.72		589	849	71.0	0.65	0.78	1.23	1.29	2.50	2.50	T4	135	M25
MVE 1300/075	299.60		941	1355	99.8	1.00	1.10	1.86	1.83	3.00	3.00	T4	135	M25
MVE 2100/075	467.41		1468	2114	150.4	1.50	1.80	2.81	2.89	4.20	4.10	T4	135	M32
MVE 3100/075	680.34		2137	3077	212.2	2.00	2.30	3.79	3.77	4.00	4.00	T4	135	M32
MVE 3800/075	838.43		2633	3792	230.2	2.50	3.00	6.00	6.00	3.90	4.00	T4	135	M32
MVE 4200/075	929.74		2920	4205	284.5	2.90	3.40	6.50	6.50	3.80	3.70	T4	135	M32
MVE 5300/075	1165.22		3660	5270	305	4.00	4.30	8.50	8.00	3.80	4.20	T4	135	M32
MVE 6500/075	1435.85		4510	6494	324.4	5.00	5.90	10.00	10.00	3.60	4.00	T4	135	M32

TYPE	Mechanical Features					Electric Features									
	Working moment (*)		FC		Weight	Power		Current		Ia/In		Ⓜ	Ⓜ	Cable Glende	
	Kgcm		Kg		Kg	Kw		A max (Δ)				Class II Div.2	II3 D		
	50Hz	60Hz	50Hz	60Hz	50Hz - 60Hz	50 Hz	60 Hz	50 Hz	60 Hz	50Hz	60Hz	Temp. Class	Temp. Class		
							400V	460V			(T)	(°C)			
MVE 10000/075	2200.43		6911	9952	422.2	6.80	7.50	13.50	12.5	3.5	4.2	T4	135	M32	
MVE 12000/075	2835	2553	8904	11546	571	553	7.5	8	14	13.5	3.8	4	/	135	M32
MVE 14000/075	3713	3220	11661	14563	751	725	9.2	9.5	21	19	4.5	5	/	135	M32
MVE 17000/075	4401	3920	13822	17729	812	792	10.5	11	22	20	5.3	5.8	/	135	M32
MVE 22000/075	5857	4999	18395	22610	982	937	12.5	16	26	28	5.6	5.2	/	135	M32
MVE 26000/090	/	5857	/	5084	/	982	/	16	/	28	/	5.2	/	135	M32

(*) = Working moment = 2 x static moment

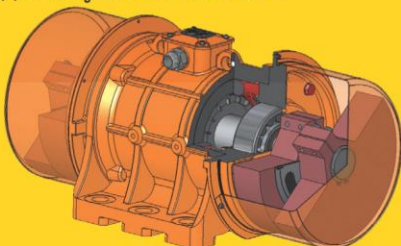
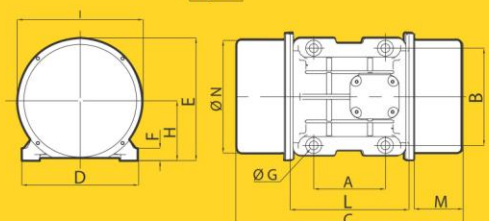

Fig D



CE Declaration of conformity "type B" according to:
- 2006/95/EC - 2004/108/EC - 2006/42/EC - EN 60034-1

Intertek
- Class II Div.2 Group F, G - T4 - NEMA 4
- Conform to UL 1836, UL1004 Cert. CSA C22.2 N°25,100,145
- Intertek ETL - SEMCO File Number 3177001



TYPE	Dimensional Features														
	FIG.	Size	C	M	A	B	Ø G	Holes	D	E	F	H	I	L	N
			(mm) 50Hz - 60Hz	(mm) 50Hz - 60Hz	(mm)	(mm)	(mm)	(mm)	n°	(mm)	(mm)	(mm)	(mm)	(mm)	(mm)
MVE 150/075	D	40	334	78	105	140	13	4	168	196	22	92	169	178	158
MVE 250/075	D	50	391	93	120	170	17	4	208	210	22	94	180	205	170
MVE 400/075	D	50	451	123	120	170	17	4	208	210	22	94	180	205	170
MVE 650/075	D	60	446	96	140	190	17	4	229	247	30	120	247	220	222
MVE 900/075	D	60	510	129	140	190	17	4	229	247	30	120	247	220	222
MVE 1300/075	D	70	556	140	155	225	22	4	272	284	40	140	267	250	235
MVE 2100/075	D	75	708	200	155	255	23.5	4	302	318	35	147	295	273	264
MVE 3100/075	D	80	683	170	180	280	26	4	332	360	37	167	345	304	310
MVE 3800/075	D	80	733	195	180	280	26	4	332	360	37	167	345	304	310
MVE 4200/075	D	85	685	160	200	320	28	4	385	410	49	199	422	325	378
MVE 5300/075	D	85	685	160	200	320	28	4	385	410	49	199	422	325	378
MVE 6500/075	D	85	785	210	200	320	28	4	385	410	49	199	422	325	378

TYPE	Dimensional Features														
	FIG.	Size	C	M	A	B	Ø G	Holes	D	E	F	H	I	L	N
			(mm) 50Hz - 60Hz	(mm) 50Hz - 60Hz	(mm)	(mm)	(mm)	(mm)	n°	(mm)	(mm)	(mm)	(mm)	(mm)	(mm)
MVE 10000/075	E	90	926	260	125	380	38	6	452	430	44	204	422	367	378
MVE 12000/075	E	100	1020	275	140	440	45	6	530	484	37	232	446	470	424
MVE 14000/075	H	105	1060	250	140	480	45	8	570	542	48	268	510	560	490
MVE 17000/075	H	105	1120	280	140	480	45	8	570	542	48	268	510	560	490
MVE 22000/075	H	110	1130	285	140	520	45	8	610	594	42	297	560	560	530
MVE 26000/090	H	110	1130	285	140	520	45	8	610	594	42	297	560	560	530

NOTE: Dimensions with coarse degree of accuracy related to UNI 22768/1

Fig E

Fig.H

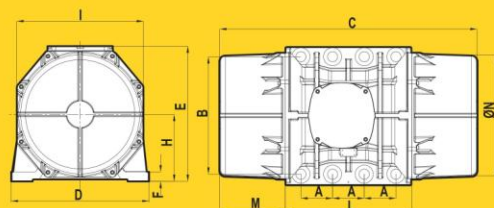
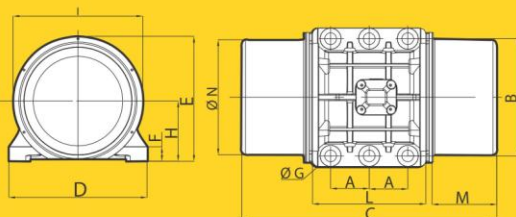

MVE - Standard Range

▶ 2 POLES SINGLE PHASE 3000 - 3600 rpm



- II 3 D Ex tD A22 Tx IP66
- TUV NORD Statement Conformity Number TUV 05 ATEX 2768X
- Equipment and protective system intended for use in potentially explosive atmospheres (Zone 22) - Directive 94/9/EC
- Compliance with Essential Health and Safety Requirements
- EN 61241-10

TYPE	Mechanical Features			Electric Features						
	Working moment (*)	FC	Weight	Power	Current	Ia/In	Ex II 3 D	Cable	CAPACITOR	
	Kgcm	Kg	Kg	Kw	A max (Y)					Temp. Class
	50Hz	50Hz	50Hz	50 Hz	50 Hz					(°C)
MVE 60/3M	1.31	66	4.2	0.08	0.43	3.0	100	M16	3 µF	
MVE 100/3M	1.96	98	4.6	0.1	0.54	3.0	100	M16	4 µF	
MVE 200/3M	3.72	187	7.0	0.18	1.14	3,3	100	M20	8 µF	
MVE 202/3M	3.72	187	7.2	0.18	1.14	3,3	100	M20	8 µF	
MVE 300/3M	6.39	321	9.8	0.27	1.58	3.60	100	M20	12.5 µF	

TYPE	Mechanical Features			Electric Features						
	Working moment (*)	FC	Weight	Power	Current	Ia/In	Class II Div.2	Ex II 3 D	Cable	CAPACITOR
	Kgcm	Kg	Kg	Kw	A max (Y)		Temp. Class	Temp. Class		
	60Hz	60Hz	60Hz	60 Hz	60 Hz		(T)	(°C)		
MVE 60/3M	0.98	71	4.2	0.09	1.03	3.0	T4	100	M16	6.3 µF
MVE 100/3M	1.31	95	4.6	0.11	1.3	3.0		100	M16	8 µF
MVE 200/3M	2.61	189	7.0	0.21	2.62	3.30	T4	100	M20	16 µF
MVE 202/3M	2.61	189	7.2	0.21	2.62	3.30	T4	100	M20	16 µF
MVE 300/3M	4.46	323	9.8	0.28	3.43	3.50	T4	100	M20	25 µF

(*) = Working moment = 2 x static moment

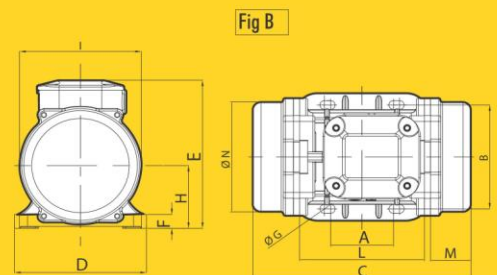
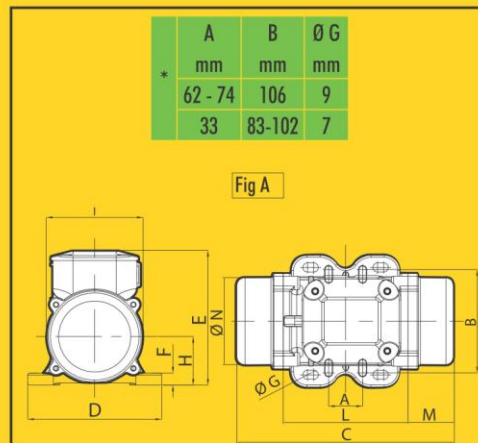
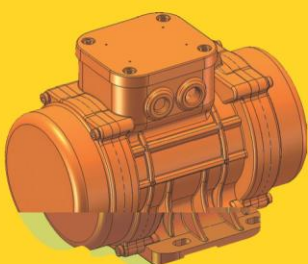

CE Declaration of conformity "type B" according to:
- 2006/95/EC - 2004/108/EC - 2006/42/EC - EN 60034-1

Intertek
- Class II Div.2 Group F, G - T4 - NEMA 4
- Conform to UL 1836, UL1004 Cert. CSA C22.2 N°25,100,145
- Intertek ETL - SEMCO File Number 3177001



TYPE	Dimensional Features																
	FIG.	Size	C (mm)		M (mm)		A (mm)	B (mm)	Ø G (mm)	Holes n°	D (mm)	E (mm)	F (mm)	H (mm)	I (mm)	L (mm)	N (mm)
			50Hz	60Hz	50Hz	60Hz											
MVE 60/3M	A	10	211	45	*	*	*	4	130	136	12	48	94	121	85		
MVE 100/3M	A	10	211	45	*	*	*	4	130	136	12	48	94	121	85		
MVE 200/3M	B	20	231	54	62-74	106	9	4	131	159	15	64	121	123	112		
MVE 202/3M	G	23	218	53	**	**	**	4	164	140	25	82	116	159	110		
MVE 300/3M	C	30	273	55	***	***	***	4	154	175	15	79	142	163	131		

NOTE: Dimensions with coarse degree of accuracy related to UNI 22768/1

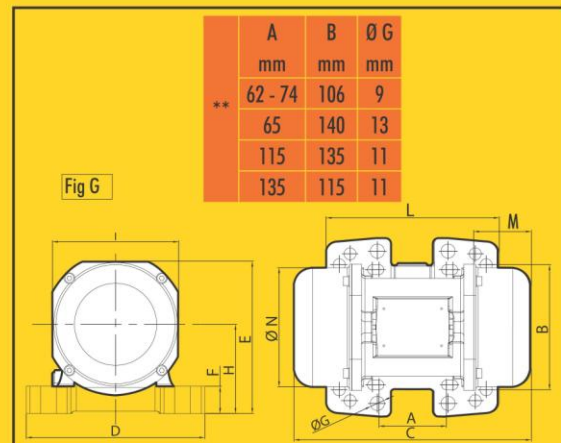
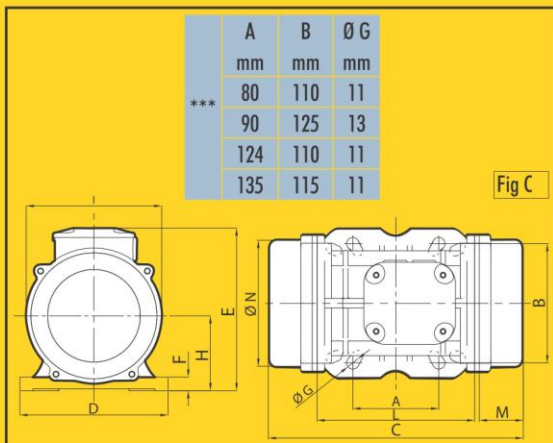

MVE - Standard Range

▶ MICRO MVE 3000 - 3600 rpm



- II3 D Ex tD A22 Tx IP66
- TUV NORD Statement Conformity Number TUV 05 ATEX 2768X
- Equipment and protective system intended for use in potentially explosive atmospheres (Zone 22) - Directive 94/9/EC
- Compliance with Essential Health and Safety Requirements - EN 61241-10

THREE PHASE	Mechanical Features					Electric Features							
	Working moment (*)		FC		Weight	Power		Current			For 60 Hz	For 50 Hz	Cable
	Kgcm		Kg			Kg	50 Hz	60 Hz	A max			Ⓜ Class II Div.2	
TYPE	50Hz	60Hz	50Hz	60Hz	50Hz				50 Hz	60 Hz	50 Hz	50 Hz	60 Hz
MICRO 21/3	0.40	0.40	20	29	2	0.03	0.04	0.17	0.10	0.12	T4	100	M16
MICRO 41/3	0.86	0.86	44	62	2.4	0.07	0.07	0.30	0.25	0.25	T4	100	M16

(*) = Working moment = 2 x static moment

SINGLE PHASE	Mechanical Features					Electric Features						
	Working moment (*)		FC		Weight	Power		Current		For 60 Hz	For 50 Hz	Cable
	Kgcm		Kg			Kg	50 Hz	60 Hz	A max		Ⓜ Class II Div.2	
TYPE	50Hz	60Hz	50Hz	60Hz	50Hz				50 Hz	60 Hz	50 Hz	60 Hz
MICRO 3/3 M	0.08	0.08	4	6	1.6	0.02	0.02	0.15	0.30	T4	100	M16
MICRO 6/3 M	0.12	0.12	6	9	1.6	0.02	0.02	0.15	0.30	T4	100	M16
MICRO 21/3 M	0.40	0.40	20	29	2	0.04	0.04	0.20	0.40	T4	100	M16
MICRO 41/3 M	0.90	0.90	45	65	2.4	0.05	0.05	0.25	0.50	T4	100	M16

(*) = Working moment = 2 x static moment

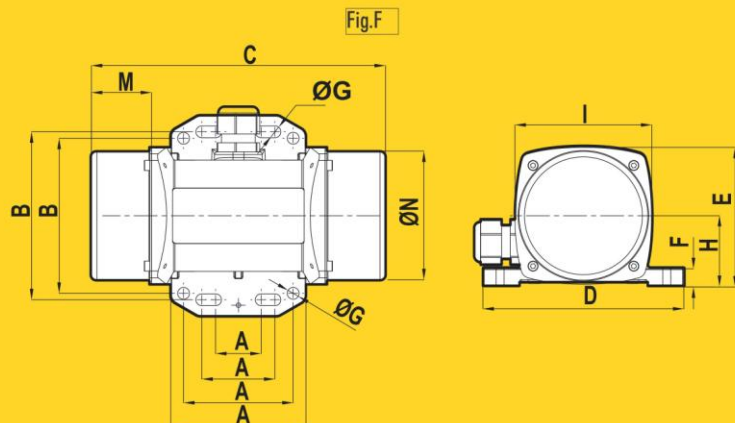
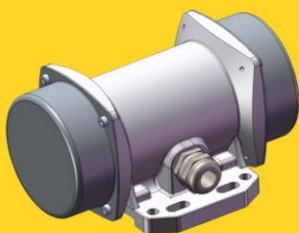

CE Declaration of conformity "type B" according to:
- 2006/95/EC - 2004/108/EC - 2006/42/EC - EN 60034-1

Intertek
- Class II Div.2 Group F, G - T4 - NEMA 4
- Conform to UL 1836, UL1004 Cert. CSA C22.2 N°25,100,145
- Intertek ETL - SEMCO File Number 3177001



TYPE	Dimensional Features													
	FIG.	C	M	A	B	Ø G	Holes	D	E	F	H	I	L	N
		(mm) 50Hz	(mm) 50Hz	(mm)	(mm)	(mm)	n°	(mm)	(mm)	(mm)	(mm)	(mm)	(mm)	(mm)
MICRO 21/3	F	145	25	25-40 60	92 85	6.5 6.5	4	110	76.5	10	39	75	74	70.5
MICRO 41/3	F	169	37	25-40 60	92 85	6.5 6.5	4	110	76.5	10	39	75	74	70.5

NOTE: Dimensions with coarse degree of accuracy related to UNI 22768/1

TYPE	Dimensional Features													
	FIG.	C	M	A	B	Ø G	Holes	D	E	F	H	I	L	N
		(mm) 50Hz	(mm) 50Hz	(mm)	(mm)	(mm)	n°	(mm)	(mm)	(mm)	(mm)	(mm)	(mm)	(mm)
MICRO 3/3 M	F	145	25	25-40 60	92 85	6.5 6.5	4	110	76.5	10	39	75	74	70.5
MICRO 6/3 M	I	145	25	25-40 /	75 /	6.5 /	4	90	76.5	10	39	75	74	70.5
MICRO 21/3 M	F	145	25	25-40 60	92 85	6.5 6.5	4	110	76.5	10	39	75	74	70.5
MICRO 41/3 M	F	169	37	25-40 60	92 85	6.5 6.5	4	110	76.5	10	39	75	74	70.5

NOTE: Dimensions with coarse degree of accuracy related to UNI 22768/1

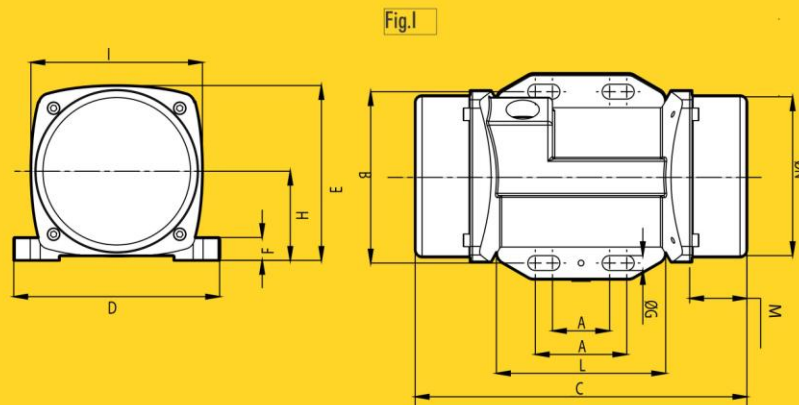

MVE - Standard Range

▶ DC

3000 rpm



- II3 D Ex tD A22 Tx IP66
- TUV NORD Statement Conformity Number TUV 05 ATEX 2768X
- Equipment and protective system intended for use in potentially explosive atmospheres (Zone 22) - Directive 94/9/EC
- Compliance with Essential Health and Safety Requirements
- EN 61241-10

TYPE	Mechanical Features				Electric Features			
	RPM	Working moment (*) Kgcm	FC Kg	Weight Kg	Power Kw	Current A max	Ex	Cable Glande
							II3 D Temp. Class (°C)	
MVE 202 DC 24	3000	4.17	200	7.2	0.16	6.7	100	M20
MVE 202 DC 12	3000	4.17	200		0.16	13.3	100	M20
MVE 50 DC 24	3000	1.02	50	4.4	0.08	3.3	100	M16
MVE 50 DC 12	3000	1.02	50		0.08	6.6	100	M16

(*) = Working moment = 2 x static moment

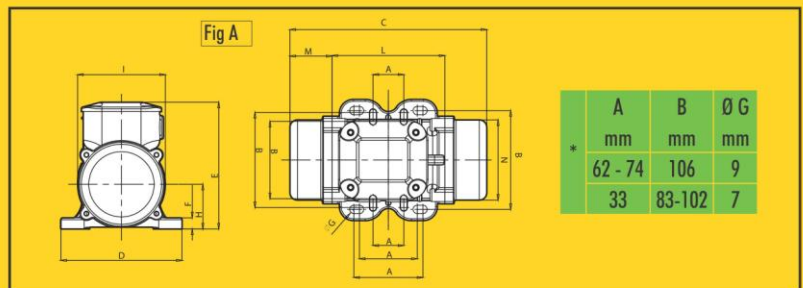
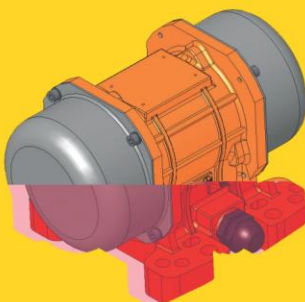

CE Declaration of conformity "type B" according to:
- 2006/95/EC - 2004/108/EC - 2006/42/EC - EN 60034-1



TYPE	Dimensional Features														
	FIG.	Size	C (mm) 50Hz	M (mm) 50Hz	A	B	Ø G	Holes	D	E	F	H	I	L	N
					(mm)	(mm)	(mm)	n°	(mm)	(mm)	(mm)	(mm)	(mm)	(mm)	(mm)
MVE 202 DC 24	G	23	218	53	**	**	**	4	164	140	25	82	116	159	110
MVE 202 DC 12	G	23	218	53	**	**	**	4	164	140	25	82	116	159	110
MVE 50 DC 24	A	10	211	45	*	*	*	4	130	136	12	48	94	121	85
MVE 50 DC 12	A	10	211	45	*	*	*	4	130	136	12	48	94	121	85

NOTE: Dimensions with coarse degree of accuracy related to UNI 22768/1

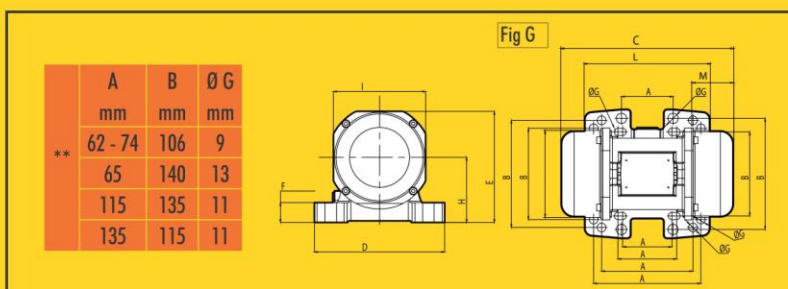

MVE-E Increased Safety Range

▶ 2 POLES

3000 - 3600 rpm



Ex e II T3 Ex tD A21 T150°C IP66
II 2 GD
Standard ref.: IEC60079-0; IEC60079-7; IEC61241-0; IEC61241-1



Declaration of conformity "type B" according to:
- 2006/95/EC - 2004/108/EC - 2006/42/EC - EN 60034-1

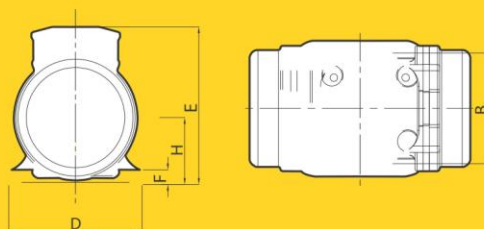

IEC
IECEX
Standard ref.:
IEC60079-0; IEC60079-7; IEC61241-0; IEC61241-1
IECEX BAS 06.0068X/2

Baseefa
Certificate number Baseefa 06ATEX0281X/2

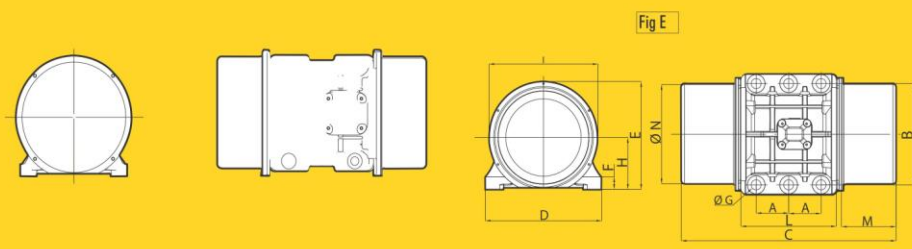

MVE-E Increased Safety Range

► 4 POLES

1500 - 1800 rpm



Ex e II T3 Ex tD A21 T150°C IP66
II 2 GD
Standard ref.: IEC60079-0; IEC60079-7; IEC61241-0; IEC61241-1



Declaration of conformity "type B" according to:
- 2006/95/EC - 2004/108/EC - 2006/42/EC - EN 60034-1

TYPE	Mechanical Features						Electric Features										
	Working moment (*)		FC		Weight		Power		Current		Ia/In		t _e		Max Amb		Cable
	Kgcm		Kg		Kg		Kw		A max (Y)								
	50Hz	60Hz	50Hz	60Hz	50Hz	60Hz	50 Hz	60 Hz	50 Hz	60 Hz	50Hz	60Hz	50Hz	60Hz	50Hz	60Hz	Glande
MVE 200/15E	15.44	10.83	194	196	11.8		0.16	0.17	0.49	0.50	2.00	2.00	60	60	40.0	40.0	
MVE 400/15E	33.43	23.38	420	423	19.5		0.30	0.35	0.84	0.86	2.50	2.50	30	30	40.0	40.0	M20
MVE 500/15E	40.12	28.08	504	508	21.0		0.35	0.40	1.06	1.09	2.80	2.70	22	22	40.0	40.0	M20
MVE 300/15E	26.58	18.60	334	336	22.5		0.62	0.73	1.32	1.41	3.00	3.20	20	19	40.0	40.0	M20
MVE 700/15E	56.83	39.36	714	712	27.4		0.62	0.73	1.32	1.41	3.00	3.20	20	19	40.0	40.0	M20
MVE 1100/15E	88.67	62.02	1114	1122	35.8		0.65	0.78	1.50	1.70	3.80	3.80	12	12	40.0	40.0	M20
MVE 1400/15E	108.57	76.72	1364	1388	59.8	58.2	0.90	1.10	1.71	1.78	4.00	4.00	12	12	40.0	40.0	M25
MVE 1700/15E	137.31	91.98	1725	1664	61.8	59.4	1.15	1.30	2.16	2.09	4.70	4.50	9	9	40.0	40.0	M25
MVE 2400/15E	187.69	137.36	2358	2485	68.0	62.0	1.60	1.90	3.00	3.20	4.90	4.90	8	8	40.0	40.0	M25
MVE 2500/15E	203.53	135.65	2557	2454	90.0	84.0	1.80	2.00	3.40	3.40	6.00	6.10	6	6	40.0	40.0	M25
MVE 3000/15E	248.66	169.75	3124	3071	97.5	87.0	1.90	2.30	3.70	3.80	6.50	6.60	6	6	40.0	40.0	M25
MVE 3800/15E	306.69	204.74	3853	3704	130.4	118.4	2.20	2.60	4.12	4.15	6.80	6.80	5	5	40.0	40.0	M32
MVE 4300/15E	343.22	240.95	4312	4359	134.4	123.6	2.50	3.00	5.70	5.80	7.00	7.20	5	5	40.0	40.0	M32
MVE 5500/15E	437.39	303.74	5495	5495	192.2	190.0	3.60	3.45	6.50	6.60	7.10	7.00	5	5	40.0	40.0	M32

TYPE	Mechanical Features						Electric Features										
	Working moment (*)		FC		Weight		Power		Current		Ia/In		t _e		Max Amb		Cable
	Kgcm		Kg		Kg		Kw		A max (Δ)								
	50Hz	60Hz	50Hz	60Hz	50Hz	60Hz	50 Hz	60 Hz	50 Hz	60 Hz	50Hz	60Hz	50Hz	60Hz	50Hz	60Hz	Glande
MVE 7200/15E	576.76	397.32	7246	7188	253.0	246.6	5.00	6.00	9.60	9.41	6.80	6.90	5.00	5.00	40.0	40.0	
MVE 9000/15E	717.97	498.76	9020	9023	268.6	257.8	7.50	8.50	12.00	12.00	7.00	7.00	5.00	5.00	40.0	40.0	M32

(*) = Working moment = 2 x static moment

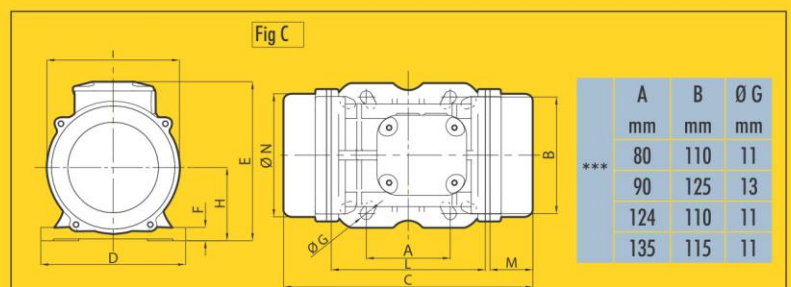
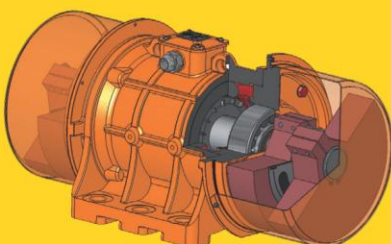

IEC Standard ref.:
IEC60079-0; IEC60079-7; IEC61241-0; IEC61241-1
IECEX BAS 06.0068X/2



Baseefa Certificate number Baseefa 06ATEX0281X/2

TYPE	Dimensional Features																
	FIG.	Size	C (mm)		M (mm)		A (mm)	B (mm)	Ø G (mm)	Holes n°	D (mm)	E (mm)	F (mm)	H (mm)	I (mm)	L (mm)	N (mm)
			50Hz	60Hz	50Hz	60Hz											
MVE 200/15E	C	30	273		55	***	***	***	4	154	175	15	79	142	163	131	
MVE 400/15E	D	40	334		78	105	140	13	4	168	196	22	92	169	178	158	
MVE 500/15E	D	40	334		78	105	140	13	4	168	196	22	92	169	178	158	
MVE 300/15E	D	50	321		58	120	170	17	4	208	210	22	94	180	205	170	
MVE 700/15E	D	50	391		93	120	170	17	4	208	210	22	94	180	205	170	
MVE 1100/15E	D	50	451		123	120	170	17	4	208	210	22	94	180	205	170	
MVE 1400/15E	D	60	446		96	140	190	17	4	229	247	30	120	247	220	222	
MVE 1700/15E	D	60	446		96	140	190	17	4	229	247	30	120	247	220	222	
MVE 2400/15E	D	60	510	446	129	96	140	190	17	4	229	247	30	120	247	220	222
MVE 2500/15E	D	70	522	486	123	105	155	225	22	4	272	284	40	140	267	250	235
MVE 3000/15E	D	70	556	486	123	105	155	225	22	4	272	284	40	140	267	250	235
MVE 3800/15E	D	75	588	538	140	115	155	255	23.5	4	302	318	35	147	295	273	264
MVE 4300/15E	D	75	588		140	155	255	23.5	4	302	318	35	147	295	273	264	
MVE 5500/15E	D	80	603		130	180	280	26	4	332	360	37	167	345	304	310	

TYPE	Dimensional Features																
	FIG.	Size	C (mm)		M (mm)		A (mm)	B (mm)	Ø G (mm)	Holes n°	D (mm)	E (mm)	F (mm)	H (mm)	I (mm)	L (mm)	N (mm)
			50Hz	60Hz	50Hz	60Hz											
MVE 7200/15E	D	85	605		120	200	320	28	4	385	410	49	200	422	325	378	
MVE 9000/15E	D	85	605		120	200	320	28	4	385	410	49	200	422	325	378	

NOTE: Dimensions with coarse degree of accuracy related to UNI 22768/1

Fig D

Fig E

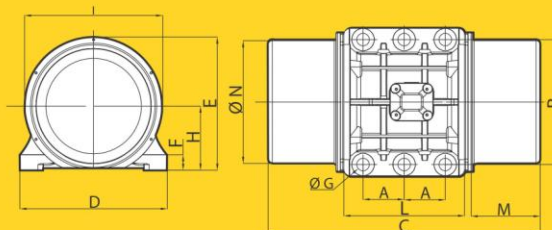
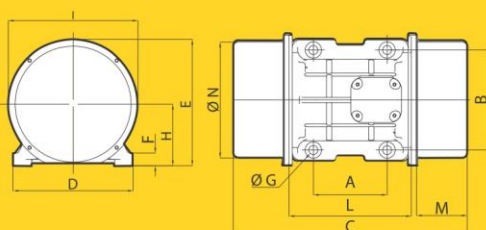

MVE-E Increased Safety Range

▶ 6 POLES

1000 - 1200 rpm



Ex e II T3 Ex tD A21 T1 50°C IP66
II 2 GD
Standard ref.: IEC60079-0; IEC60079-7; IEC61241-0; IEC61241-1



Declaration of conformity "type B" according to:
- 2006/95/EC - 2004/108/EC - 2006/42/EC - EN 60034-1

TYPE	Mechanical Features						Electric Features										Cable Glands
	Working moment (*)		FC		Weight		Power		Current		Ia/In		t _e		Max Amb		
	Kgcm		Kg		Kg		Kw		A max (Y)				(sec)		(°C)		
	50Hz	60Hz	50Hz	60Hz	50Hz	60Hz	50 Hz	60 Hz	50 Hz	60 Hz	50Hz	60Hz	50Hz	60Hz	50Hz	60Hz	
MVE 50/1E	9.49	6.59	53	53	10.4		0.12	0.14	0.40	0.40	2.00	2.00	60.0	60.0	40.0	40.0	M20
MVE 100/1E	18.80	13.18	105	106	12.2		0.12	0.14	0.40	0.40	2.00	2.00	60.0	60.0	40.0	40.0	M20
MVE 200/1E	33.49	23.38	187	188	19.6		0.18	0.21	0.53	0.51	2.00	2.00	60.0	60.0	40.0	40.0	M20
MVE 300/1E	56.93	39.85	318	320	26.6		0.35	0.38	0.67	0.64	2.50	2.50	30.0	30.0	40.0	40.0	M20
MVE 500/1E	91.88	64.32	513	517	34.0		0.35	0.40	1.20	1.15	2.80	2.70	24.0	24.0	40.0	40.0	M20
MVE 510/1E	91.88	91.88	513	739	34.5		0.35	0.40	1.20	1.15	2.80	2.70	24.0	24.0	40.0	40.0	M20
MVE 800/1E	137.37	108.58	767	873	61.8	59.4	0.68	0.76	1.29	1.26	2.80	2.80	24.0	24.0	40.0	40.0	M25
MVE 1100/1E	187.69	137.31	1048	1104	79.4	73.0	0.75	0.80	1.42	1.32	3.20	3.10	19.0	19.0	40.0	40.0	M25
MVE 1500/1E	284.76	196.51	1590	1580	83.6	76.5	1.10	1.30	2.10	2.00	3.30	3.30	16.0	16.0	40.0	40.0	M25
MVE 1600/1E	299.63	203.47	1673	1636	99.8	89.0	1.10	1.30	2.83	3.22	3.70	3.60	13.0	13.0	40.0	40.0	M25
MVE 2100/1E	373.05	248.74	2083	2000	114.3	100.5	1.50	1.80	3.00	3.00	4.30	4.40	10.0	10.0	40.0	40.0	M25
MVE 2600/1E	467.44	306.70	2610	2466	148.6	131.5	1.96	2.10	3.63	3.38	4.80	4.80	9.0	9.0	40.0	40.0	M32
MVE 3000/1E	540.33	379.71	3017	3053	155.4	137.8	2.20	2.40	4.50	4.30	5.00	5.00	8.0	8.0	40.0	40.0	M32
MVE 3800/1E	680.38	437.41	3799	3517	215.6	194.8	2.50	3.00	4.67	4.88	5.90	6.00	6.0	6.0	40.0	40.0	M32
MVE 4700/1E	838.34	584.17	4681	4697	230.8	212.4	3.20	3.90	6.50	6.00	5.50	5.70	7.0	7.0	40.0	40.0	M32
MVE 5200/1E	929.86	654.57	5192	5263	279.8	264.2	3.80	4.00	6.92	6.36	5.50	5.50	7.0	7.0	40.0	40.0	M32
MVE 6500/1E	1165.19	823.96	6506	6625	304.4	280.7	4.30	5.00	7.76	7.81	6.20	6.00	6.0	6.0	40.0	40.0	M32

TYPE	Mechanical Features						Electric Features										Cable Glands
	Working moment (*)		FC		Weight		Power		Current		Ia/In		t _e		Max Amb		
	Kgcm		Kg		Kg		Kw		A max (Δ)				(sec)		(°C)		
	50Hz	60Hz	50Hz	60Hz	50Hz	60Hz	50 Hz	60 Hz	50 Hz	60 Hz	50Hz	60Hz	50Hz	60Hz	50Hz	60Hz	
MVE 8000/1E	1435.98	929.80	8018	7476	325.2	290	7.10	7.50	12.60	11.60	6.00	6.20	6.0	6.0	40.0	40.0	M32
MVE 9000/1E	1600.39	1165.23	8936	9369	337.8	307.6	7.50	8.30	13.20	12.60	6.30	6.20	5.5	5.5	40.0	40.0	M32
MVE 10000/1E	1788.44	1239.98	9986	9970	385.8	359.3	7.60	8.00	13.50	12.70	6.40	6.40	5.5	5.5	40.0	40.0	M32

(*) = Working moment = 2 x static moment

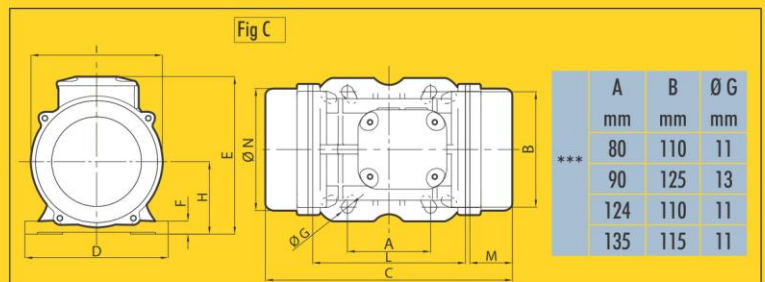

Standard ref.:
IEC60079-0; IEC60079-7; IEC61241-0; IEC61241-1
IECEX BAS 06.0068X/2



Certificate number Baseefa 06ATEX0281X/2

TYPE	Dimensional Features																
	FIG.	Size	C (mm)		M (mm)		A (mm)	B (mm)	Ø G (mm)	Holes n°	D (mm)	E (mm)	F (mm)	H (mm)	I (mm)	L (mm)	N (mm)
			50Hz	60Hz	50Hz	60Hz											
MVE 50/1E	C	30	273		55	***	***	***	4	154	175	15	79	142	163	131	
MVE 100/1E	C	30	303		70	***	***	***	4	154	175	15	79	142	163	131	
MVE 200/1E	D	40	334		78	105	140	13	4	168	196	22	92	169	178	158	
MVE 300/1E	D	50	391		93	120	170	17	4	208	210	22	94	180	205	170	
MVE 500/1E	D	50	451		123	120	170	17	4	208	210	22	94	180	205	170	
MVE 510/1E	D	50	451		123	120	170	17	4	208	210	22	94	180	205	170	
MVE 800/1E	D	60	446		96	140	190	17	4	229	247	30	120	247	220	222	
MVE 1100/1E	D	60	510	446	129	96	140	190	17	4	229	247	30	120	247	220	222
MVE 1500/1E	D	60	562	510	154	129	140	190	17	4	229	247	30	120	247	220	222
MVE 1600/1E	D	70	556	522	140	123	155	225	22	4	272	284	40	140	267	250	235
MVE 2100/1E	D	70	616	556	170	140	155	225	22	4	272	284	40	140	267	250	235
MVE 2600/1E	D	75	708	588	200	140	155	255	23.5	4	302	318	35	147	295	273	264
MVE 3000/1E	D	75	708	608	200	150	155	255	23.5	4	302	318	35	147	295	273	264
MVE 3800/1E	D	80	683	603	170	130	180	280	26	4	332	360	37	167	345	304	310
MVE 4700/1E	D	80	733	683	195	170	180	280	26	4	332	360	37	167	345	304	310
MVE 5200/1E	D	85	685	605	160	120	200	320	28	4	385	410	49	200	422	325	378
MVE 6500/1E	D	85	685		160		200	320	28	4	385	410	49	200	422	325	378

TYPE	Dimensional Features																
	FIG.	Size	C (mm)		M (mm)		A (mm)	B (mm)	Ø G (mm)	Holes n°	D (mm)	E (mm)	F (mm)	H (mm)	I (mm)	L (mm)	N (mm)
			50Hz	60Hz	50Hz	60Hz											
MVE 8000/1E	D	85	785	685	210	160	200	320	28	4	385	410	49	200	422	325	378
MVE 9000/1E	D	85	785	685	210	160	200	320	28	4	385	410	49	200	422	325	378
MVE 10000/1E	E	90	826		210		125	380	38	6	452	430	44	204	422	367	378

NOTE: Dimensions with coarse degree of accuracy related to UNI 22768/1

Fig D

Fig E

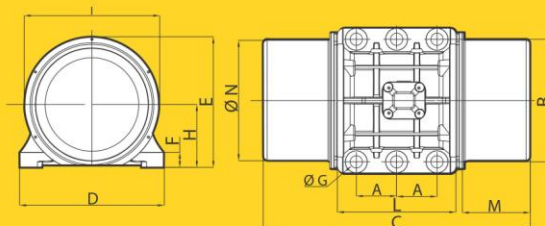
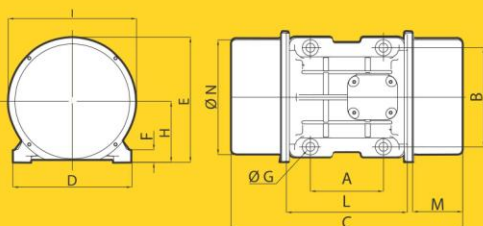

MVE-E Increased Safety Range

► 8 POLES

750 - 900 rpm



Ex e II T3 Ex tD A21 T150°C IP66
II 2 GD
Standard ref.: IEC60079-0; IEC60079-7; IEC61241-0; IEC61241-1



Declaration of conformity "type B" according to:
- 2006/95/EC - 2004/108/EC - 2006/42/EC - EN 60034-1

TYPE	Mechanical Features				Electric Features										
	Working moment (*) Kgcm 50Hz - 60Hz	FC Kg		Weight Kg 50Hz - 60Hz	Power Kw		Current A max (Y)		Ia/In		Ex				Cable Glande
		50Hz	60Hz		50 Hz	60 Hz	50 Hz	60 Hz	50Hz	60Hz	t _E		Max Amb		
											(sec)	(sec)	(°C)	(°C)	
MVE 150/075E	33.39	105	151	21.4	0.23	0.25	1.14	1.14	1.50	1.50	30.0	30.0	40.0	40.0	M20
MVE 250/075E	56.93	179	257	29.5	0.35	0.38	1.15	1.15	1.70	1.70	30.0	30.0	40.0	40.0	M20
MVE 400/075E	84.02	264	380	35.0	0.35	0.38	1.15	1.15	1.90	1.90	30.0	30.0	40.0	40.0	M20
MVE 650/075E	137.31	431	621	64.7	0.50	0.60	1.20	1.20	2.20	2.20	30.0	30.0	40.0	40.0	M25
MVE 900/075E	187.72	589	849	71.0	0.65	0.78	1.23	1.29	2.50	2.50	25.0	25.0	40.0	40.0	M25
MVE 1300/075E	299.60	941	1355	99.8	1.00	1.10	1.86	1.83	3.00	3.00	20.0	20.0	40.0	40.0	M25
MVE 2100/075E	467.41	1468	2114	150.4	1.50	1.80	2.81	2.89	4.20	4.10	12.0	12.0	40.0	40.0	M32
MVE 3100/075E	680.39	2137	3077	212.2	2.00	2.30	3.79	3.77	4.00	4.00	12.0	12.0	40.0	40.0	M32
MVE 3800/075E	838.43	2633	3792	230.2	2.50	3.00	6.00	6.00	3.90	4.00	12.0	12.0	40.0	40.0	M32
MVE 4200/075E	929.74	2920	4205	284.5	2.90	3.40	6.50	6.50	3.80	3.70	13.0	13.0	40.0	40.0	M32
MVE 5300/075E	1165.22	3660	5270	305	4.00	4.30	8.50	8.00	3.80	4.20	13.0	12.0	40.0	40.0	M32
MVE 6500/075E	1435.85	4510	6494	324.4	5.00	5.90	10.00	10.00	3.60	4.00	14.0	12.0	40.0	40.0	M32

TYPE	Mechanical Features				Electric Features										
	Working moment (*) Kgcm 50Hz - 60Hz	FC Kg		Weight Kg 50Hz - 60Hz	Power Kw		Current A max (Δ)		Ia/In		Ex				Cable Glande
		50Hz	60Hz		50 Hz	60 Hz	50Hz	60Hz	t _E		Max Amb				
									(sec)	(sec)	(°C)	(°C)			
MVE 10000/075E	2200.43	6911	9952	422.2	6.80	7.50	13.50	12.5	3.5	4.2	24.8	22.8	40.0	40.0	M32

(*) = Working moment = 2 x static moment

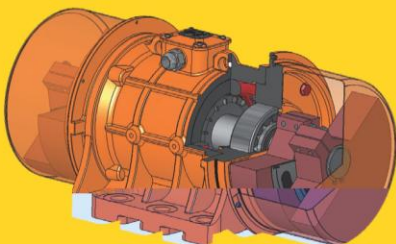
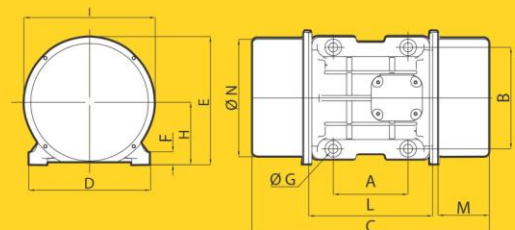

Fig D



IEC Standard ref.:
IEC60079-0; IEC60079-7; IEC61241-0; IEC61241-1
IECEX BAS 06.0068X/2



Baseefa Certificate number Baseefa 06ATEX0281X/2

TYPE	Dimensional Features														
	FIG.	Size	C (mm) 50Hz - 60 Hz	M (mm) 50Hz - 60 Hz	A	B	Ø G	Holes	D	E	F	H	I	L	N
					(mm)	(mm)	(mm)	n°	(mm)	(mm)	(mm)	(mm)	(mm)	(mm)	(mm)
MVE 150/075E	D	40	334	78	105	140	13	4	168	196	22	92	169	178	158
MVE 250/075E	D	50	391	93	120	170	17	4	208	210	22	94	180	205	170
MVE 400/075E	D	50	451	123	120	170	17	4	208	210	22	94	180	205	170
MVE 650/075E	D	60	446	96	140	190	17	4	229	247	30	120	247	220	222
MVE 900/075E	D	60	510	129	140	190	17	4	229	247	30	120	247	220	222
MVE 1300/075E	D	70	556	140	155	225	22	4	272	284	40	140	267	250	235
MVE 2100/075E	D	75	708	200	155	255	23.5	4	302	318	35	147	295	273	264
MVE 3100/075E	D	80	683	170	180	280	26	4	332	360	37	167	345	304	310
MVE 3800/075E	D	80	733	195	180	280	26	4	332	360	37	167	345	304	310
MVE 4200/075E	D	85	685	160	200	320	28	4	385	410	49	199	422	325	378
MVE 5300/075E	D	85	685	160	200	320	28	4	385	410	49	199	422	325	378
MVE 6500/075E	D	85	785	210	200	320	28	4	385	410	49	199	422	325	378

TYPE	Dimensional Features														
	FIG.	Size	C (mm) 50Hz - 60 Hz	M (mm) 50Hz - 60 Hz	A	B	Ø G	Holes	D	E	F	H	I	L	N
					(mm)	(mm)	(mm)	n°	(mm)	(mm)	(mm)	(mm)	(mm)	(mm)	(mm)
MVE 10000/075E	E	90	926	260	125	380	38	6	452	430	44	204	422	367	378

NOTE: Dimensions with coarse degree of accuracy related to UNI 22768/1

Fig E

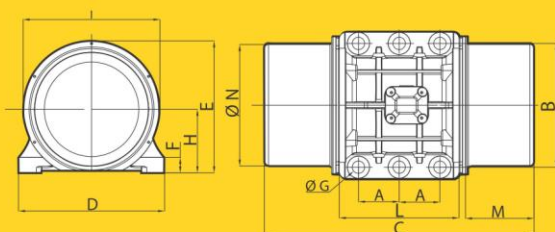

MVE-D Explosion Proof Range

▶ 2 POLES

3000 - 3600 rpm

CE Declaration of conformity "type B" according to:
- 2006/95/EC - 2004/108/EC - 2006/42/EC - EN 60034-1

MVE-D: II 2GD Ex d IIB T4 Ex tD A21 IP66 T135°C

Ex d IIB T4 Gb

Ex tD A21 IIIC T135°C Db IP66

CLASS I DIV.1 GROUPS C,D CLASS II DIV.1 GROUPS EFG T4 IP 66

MVE-D5: II 2G Ex d IIB T3

Ex d IIB T3 Gb

CLASS I DIV.1 GROUPS C,D T3

TYPE	Mechanical Features						Electric Features								
	Working moment (*)		FC		Weight		Power		Current		Ia/In				Cable Glande
	Kgcm		Kg		Kg		50 Hz	60 Hz	50 Hz	60 Hz	50Hz	60Hz	Dust (°C)	Gas T	
	50Hz	60Hz	50Hz	60Hz	50Hz	60Hz									
MVE 800/3D	15.68	11.06	794	800	29.0		0.75	0.90	1.45	1.50	3.80	3.80	135	T4	
MVE 1300/3D	26.58	18.60	1355	1365	30.4		1.30	1.38	2.44	2.25	5.20	5.00	135	T4	M20
MVE 1600/3D	31.26	22.22	1601	1608	60.0	59.6	1.57	1.60	2.94	2.61	5.90	6.20	135	T4	M25
MVE 2000/3D	36.78	27.60	2027	1997	61.2	60.4	2.00	2.10	3.75	3.42	6.50	6.40	135	T4	M25
MVE 2300/3D	45.97	31.87	2302	2306	62.0	60.0	2.40	2.45	4.44	3.94	6.00	6.30	135	T4	M25
MVE 3200/3D	68.10	43.89	3252	3176	111.4	109.8	2.90	2.90	5.30	4.61	8.30	8.20	135	T4	M32
MVE 4000/3D	79.40	55.99	4033	4052	115.4	111.4	2.90	2.90	5.30	4.61	8,5	9,7	135	T4	M32

(*) = Working moment = 2 x static moment

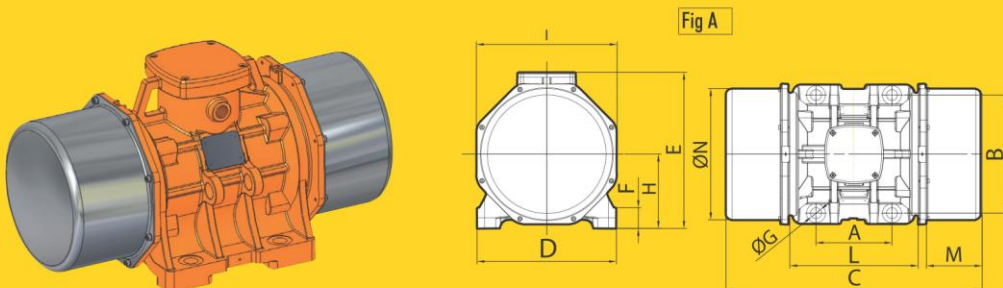

Standard ref.:
IEC60079-0; IEC60079-1; IEC61241-0; IEC61241-1
IECEX TUN 08.0012X

Cert. no: TUV 08 ATEX 362386 X

CONF. TO UL 1836, UL 1004
CERT. CSA C22.2 NO 25,100, 145



TYPE	Dimensional Features														
	FIG.	Size	C (mm) 50Hz - 60 Hz	M (mm) 50Hz - 60 Hz	A	B	Ø G	Holes	D	E	F	H	I	L	N
					(mm)	(mm)	(mm)	n°	(mm)	(mm)	(mm)	(mm)	(mm)	(mm)	(mm)
MVE 800/3D	A	50	335	65	120	170	17	4	209	240	28	103	195	205	166.5
MVE 1300/3D	A	50	335	65	120	170	17	4	209	240	28	103	195	205	166.5
MVE 1600/3D	A	60	478	105	140	190	17	4	234	267	31	124	238	234	222
MVE 2000/3D	A	60	478	105	140	190	17	4	234	267	31	124	238	234	222
MVE 2300/3D	A	63	478	105	140	190	22	4	234	267	31	124	238	234	222
MVE 3200/3D	A	75	569	115	155	255	23.5	4	300	321	35	147	285	298	265
MVE 4000/3D	A	75	569	115	155	255	23.5	4	300	321	35	147	285	298	265

NOTE: Dimensions with coarse degree of accuracy related to UNI 22768/1

MVE-D Explosion Proof Range



CE Declaration of conformity "type B" according to:
- 2006/95/EC - 2004/108/EC - 2006/42/EC - EN 60034-1

 II 2GD Ex d IIB T4 Ex tD A21 IP66 T135°C
Ex d IIB T4 Gb

Standard ref.:
IEC60079-0; IEC60079-1; IEC61241-0; IEC61241-1
IECEX TUN 08.0012X

Cert. no: TUV 08 ATEX 362386 X

CONF. TO UL 1836, UL 1004
CERT. CSA C22.2 NO 25,100, 145



TYPE	Dimensional Features																
	FIG.	Size	C (mm)		M (mm)		A (mm)	B (mm)	Ø G (mm)	Holes n°	D (mm)	E (mm)	F (mm)	H (mm)	I (mm)	L (mm)	N (mm)
			50Hz	60Hz	50Hz	60Hz											
MVE 700/15D	A	50	405		100		120	170	17	4	209	240	28	103	195	205	167
MVE 1100/15D	A	50	467	405	131	100	120	170	17	4	209	240	28	103	195	205	167
MVE 1400/15D	A	60	478		105		140	190	17	4	234	267	31	124	238	234	222
MVE 1700/15D	A	63	478		105		140	190	22	4	234	267	31	124	238	234	222
MVE 2400/15D	A	63	538		135		140	190	22	4	234	267	31	124	238	234	222
MVE 2500/15D	A	70	526		115		155	225	22	4	274	309	35	140	255	264	236
MVE 3000/15D	A	70	590		147		155	225	22	4	274	309	35	140	255	264	236
MVE 3800/15D	A	75	619		140		155	255	23.5	4	300	321	35	147	285	304	265
MVE 3810/15D	B	77	619		140		105	248	22	6	300	321	35	147	285	304	265
MVE 4300/15D	A	75	619		140		155	255	23.5	4	300	321	35	147	285	304	265
MVE 5500/15D	A	80	613		135		180	280	26	4	330	370	50	176	334	304	311

NOTE: Dimensions with coarse degree of accuracy related to UNI 22768/1

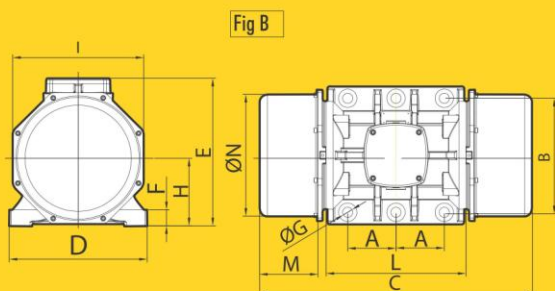

MVE-D Explosion Proof Range

▶ 6 POLES

1000 - 1200 rpm

CE Declaration of conformity "type B" according to:
- 2006/95/EC - 2004/108/EC - 2006/42/EC - EN 60034-1

MVE-D: II 2GD Ex d IIB T4 Ex tD A21 IP66 T135°C

Ex d IIB T4 Gb

Ex tD A21 IIIC T135°C Db IP66

CLASS I DIV.1 GROUPS C,D CLASS II DIV.1 GROUPS EFG T4 IP 66

MVE-D5: II 2G Ex d IIB T3

Ex d IIB T3 Gb

CLASS I DIV.1 GROUPS C,D T3

TYPE	Mechanical Features						Electric Features								
	Working moment (*)		FC		Weight		Power		Current		Ia/In				Cable
	Kgcm		Kg		Kg		Kw		A max (Y)				Dust	Gas	
	50Hz	60Hz	50Hz	60Hz	50Hz	60Hz	50 Hz	60 Hz	50 Hz	60 Hz	50Hz	60Hz	(°C)	T	
								400V 460V						Glande	
MVE 500/1D	91.88	91.88	513	739	34.0		0.35	0.4	1.2	1.2	2.8	2.7	135	T4	M20
MVE 800/1D	137	109	767	873	70.2	67.8	0.7	0.8	1.3	1.3	2.8	2.8	135	T4	M25
MVE 1100/1D	188	137	1048	1104	87.8	81.4	0.8	0.8	1.4	1.3	3.2	3.1	135	T4	M25
MVE 1500/1D	285	197	1590	1580	92.0	84.9	1.1	1.3	2.1	2.0	3.3	3.3	135	T4	M25
MVE 1600/1D	300	203	1673	1636	108.4	97.4	1.1	1.3	2.8	3.2	3.7	3.6	135	T4	M25
MVE 2100/1D	373	249	2083	2000	122.7	108.9	1.5	1.8	3.0	3.0	4.3	4.4	135	T4	M25
MVE 2600/1D	467	307	2610	2466	157.0	139.9	1.9	2.1	3.6	3.4	4.8	4.8	135	T4	M32
MVE 3000/1D	540	380	3017	3053	163.8	146.2	2.2	2.4	4.5	4.3	5.0	5.0	135	T4	M32
MVE 3800/1D	680	437	3799	3517	224.0	203.2	2.5	3.0	4.7	4.9	5.9	6.0	135	T4	M32
MVE 4700/1D	838	584	4681	4697	239.2	220.8	3.2	3.9	6.5	6.0	5.5	5.7	135	T4	M32

(*) = Working moment = 2 x static moment

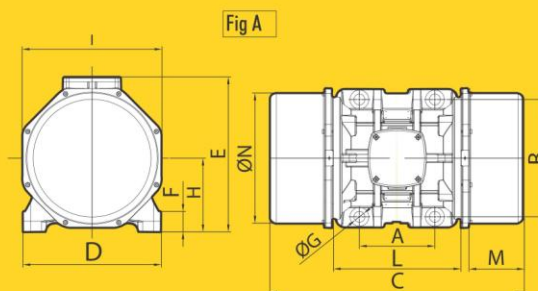
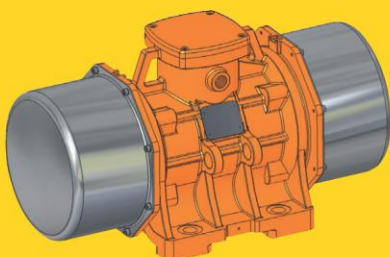

Standard ref.:
IEC60079-0; IEC60079-1; IEC61241-0; IEC61241-1
IECEX TUN 08.0012X

Cert. no: TUV 08 ATEX 362386 X

CONF. TO UL 1836, UL 1004
CERT. CSA C22.2 NO 25,100, 145



TYPE	Dimensional Features																
	FIG.	Size	C (mm)		M (mm)		A (mm)	B (mm)	Ø G (mm)	Holes n°	D (mm)	E (mm)	F (mm)	H (mm)	I (mm)	L (mm)	N (mm)
			50Hz	60Hz	50Hz	60Hz											
MVE 500/1D	A	50	467		131		120	170	17	4	209	240	28	103	195	205	167
MVE 800/1D	A	60	478		105		140	190	17	4	234	267	31	124	238	234	222
MVE 1100/1D	A	63	538		135		140	190	22	4	234	267	31	124	238	234	222
MVE 1500/1D	A	60	598		165		140	190	17	4	234	267	31	124	238	234	222
MVE 1600/1D	A	70	590		147		155	225	22	4	274	309	35	140	255	264	236
MVE 2100/1D	A	70	650		177		155	225	22	4	274	309	35	140	255	264	236
MVE 2600/1D	A	75	739		200		155	255	23.5	4	300	321	35	147	285	304	265
MVE 3000/1D	A	75	739		200		155	255	23.5	4	300	321	35	147	285	304	265
MVE 3800/1D	A	80	693		175		180	280	26	4	330	370	50	176	334	304	311
MVE 4700/1D	A	80	753		205		180	280	26	4	330	370	50	176	334	304	311

NOTE: Dimensions with coarse degree of accuracy related to UNI 22768/1

MVE-D Explosion Proof Range

► 8 POLES

750 - 900 rpm

CE Declaration of conformity "type B" according to:
- 2006/95/EC - 2004/108/EC - 2006/42/EC - EN 60034-1

MVE-D:  II 2GD Ex d IIB T4 Ex tD A21 IP66 T135°C

Ex d IIB T4 Gb

Ex tD A21 IIIC T135°C Db IP66

 CLASS I DIV.1 GROUPS C,D CLASS II DIV.1 GROUPS EFG T4 IP 66

MVE-D5:  II 2G Ex d IIB T3

Ex d IIB T3 Gb

 CLASS I DIV.1 GROUPS C,D T3

TYPE	Mechanical Features				Electric Features								
	Working moment (*) Kgcm 50Hz - 60Hz	FC Kg		Weight Kg 50Hz - 60Hz	Power Kw		Current A max (Y)		Ia/In				Cable Glande
		50Hz	60Hz		50 Hz	60 Hz	50 Hz	60 Hz	50Hz	60Hz	Dust (°C)	Gas T	
MVE 250/075D	56.93	179	257	37.9	0.35	0.38	1.15	1.15	1.70	1.70	135	T4	M20
MVE 400/075D	84.02	264	380	43.4	0.35	0.38	1.15	1.15	1.90	1.90	135	T4	M20
MVE 650/075D	137.31	431	621	73.1	0.50	0.60	1.20	1.20	2.20	2.20	135	T4	M25
MVE 900/075D	187.72	589	849	79.4	0.65	0.78	1.23	1.29	2.50	2.50	135	T4	M25
MVE 1300/075D	299.60	941	1355	108.2	1.00	1.10	1.86	1.83	3.00	3.00	135	T4	M25
MVE 2100/075D	467.41	1468	2114	158.8	1.50	1.80	2.81	2.89	4.20	4.10	135	T4	M32
MVE 3100/075D	680.34	2137	3077	220.6	2.00	2.30	3.79	3.77	4.00	4.00	135	T4	M32
MVE 3800/075D	838.43	2633	3792	238.6	2.50	3.00	6.00	6.00	3.90	4.00	135	T4	M32

(*) = Working moment = 2 x static moment

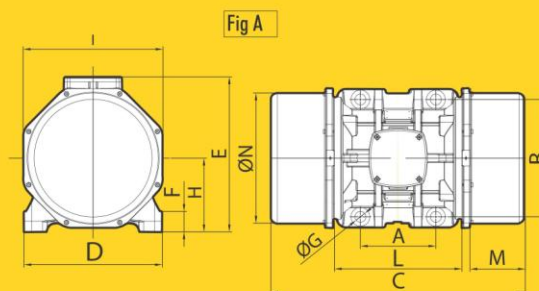
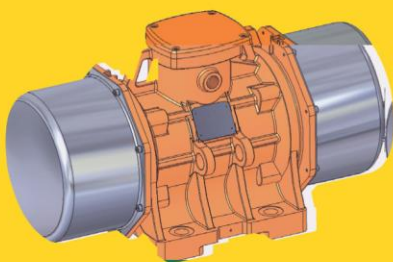

Standard ref.:
IEC60079-0; IEC60079-1; IEC61241-0; IEC61241-1
IECEX TUN 08.0012X

Cert. no: TUV 08 ATEX 362386 X

CONF. TO UL 1836, UL 1004
CERT. CSA C22.2 NO 25,100, 145



TYPE	Dimensional Features														
	FIG.	Size	C	M	A	B	Ø G	Holes	D	E	F	H	I	L	N
			(mm) 50Hz - 60 Hz	(mm) 50Hz - 60 Hz	(mm)	(mm)	(mm)	(mm)	n°	(mm)	(mm)	(mm)	(mm)	(mm)	(mm)
MVE 250/075D	A	50	405	100	120	170	17	4	209	240	28	103	195	205	167
MVE 400/075D	A	50	467	131	120	170	17	4	209	240	28	103	195	205	167
MVE 650/075D	A	60	478	105	140	190	17	4	234	267	31	124	238	234	222
MVE 900/075D	A	63	538	135	140	190	22	4	234	267	31	124	238	234	222
MVE 1300/075D	A	70	590	147	155	225	22	4	274	309	35	140	255	264	236
MVE 2100/075D	A	75	739	200	155	255	23.5	4	300	321	35	147	285	304	265
MVE 3100/075D	A	80	693	175	180	280	26	4	330	370	50	176	334	304	311
MVE 3800/075D	A	80	753	205	180	280	26	4	330	370	50	176	334	304	311

NOTE: Dimensions with coarse degree of accuracy related to UNI 22768/1

MVE-S with Split Cover

► 4 POLES

1500 - 1800 rpm

CE Declaration of conformity "type B" according to:
- 2006/95/EC - 2004/108/EC - 2006/42/EC - EN 60034-1

TYPE	Mechanical Features						Electric Features							
	Working moment (*)		FC		Weight		Power		Current		Ia/In		Ex	Cable
	Kgc _m		Kg		Kg		Kw		A max (Y)				II 3 D	
	50Hz	60Hz	50Hz	60Hz	50Hz	60Hz	50 Hz	60 Hz	50 Hz	60 Hz	50Hz	60Hz	Temp. Class	
								400V 460V				(°C)	Glande	
MVE 1400/15S	108.57	76.72	1364	1388	59.8	58.2	0.90	1.10	1.71	1.78	4.00	4.00	135	M25
MVE 1700/15S	137.31	91.98	1725	1664	61.8	59.4	1.15	1.30	2.16	2.09	4.70	4.50	135	M25
MVE 2400/15S	187.69	137.36	2358	2485	68.0	62.0	1.60	1.90	3.00	3.20	4.90	4.90	135	M25
MVE 3800/15S	306.69	204.74	3853	3704	130.4	118.4	2.20	2.60	4.12	4.15	6.80	6.80	135	M32
MVE 4300/15S	343.22	240.95	4312	4359	134.4	123.6	2.50	3.00	5.70	5.80	7.00	7.20	135	M32
MVE 5500/15S	437.39	303.74	5495	5495	192.2	190.0	3.60	3.45	6.50	6.60	7.10	7.00	135	M32

TYPE	Mechanical Features						Electric Features							
	Working moment (*)		FC		Weight		Power		Current		Ia/In		Ex	Cable
	Kgc _m		Kg		Kg		Kw		A max (Δ)				II 3 D	
	50Hz	60Hz	50Hz	60Hz	50Hz	60Hz	50 Hz	60 Hz	50 Hz	60 Hz	50Hz	60Hz	Temp. Class	
								400V 460V				(°C)	Glande	
MVE 7200/15S	576.76	397.32	7246	7188	253.0	246.6	5.00	6.00	9.60	9.41	6.80	6.90	135	M32
MVE 9000/15S	717.97	498.76	9020	9023	268.6	258	7.50	8.50	12.00	12.00	7.00	7.00	135	M32
MVE 10000/15S	800.11	588.30	10052	10643	312	297	7.80	9.40	13.00	13.00	6.50	6.40	135	M32

(*) = Working moment = 2 x static moment

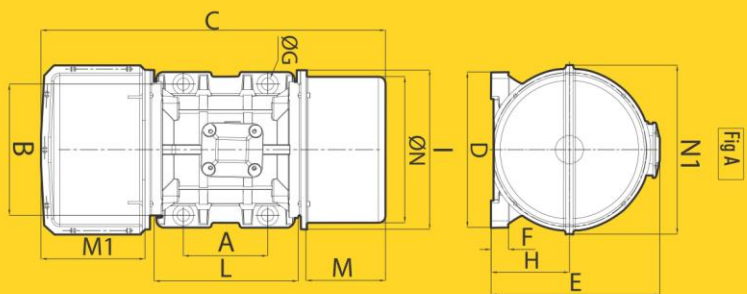

- Ex - II3 D Ex tD A22 Tx IP66
- TUV NORD Statement Conformity Number TUV 05 ATEX 2768X
- Equipment and protective system intended for use in potentially explosive atmospheres (Zone 22) - Directive 94/9/EC
- Compliance with Essential Health and Safety Requirements
- EN 61241-10



Dimensional Features																			
FIG.	Size	C (mm)		M (mm)		M1 (mm) (mm)		A (mm)	B (mm)	Ø G (mm)	Holes n°	D (mm)	E (mm)	F (mm)	H (mm)	I (mm)	L (mm)	N (mm)	N1 (mm)
		50Hz	60Hz	50Hz	60Hz	50Hz - 60Hz	50Hz - 60Hz												
A	60	538		98		188		140	190	17	4	229	247	30	120	247	220	222	272
A	60	538		98		188		140	190	17	4	229	247	30	120	247	220	222	272
A	60	569	538	128	98	188		140	190	17	4	229	247	30	120	247	220	222	272
A	75	677	652	140	115	228		155	255	23.5	4	302	318	35	147	295	273	264	315
A	75	677		140		228		155	255	23.5	4	302	318	35	147	295	273	264	315
A	80	695		130		222		180	280	26	4	332	360	37	167	340	304	310	361

Dimensional Features																			
FIG.	Size	C (mm)		M (mm)		M1 (mm) (mm)		A (mm)	B (mm)	Ø G (mm)	Holes n°	D (mm)	E (mm)	F (mm)	H (mm)	I (mm)	L (mm)	N (mm)	N1 (mm)
		50Hz	60Hz	50Hz	60Hz	50Hz - 60Hz	50Hz - 60Hz												
A	85	723		120		238		200	320	28	4	378	410	50	200	420	325	378	430
A	85	723		120		238		200	320	28	4	378	410	50	200	420	325	378	430
B	90	726	765	160	120	238		125	380	38	6	452	430	44	204	424	367	382	430

NOTE: Dimensions with coarse degree of accuracy related to UNI 22768/1

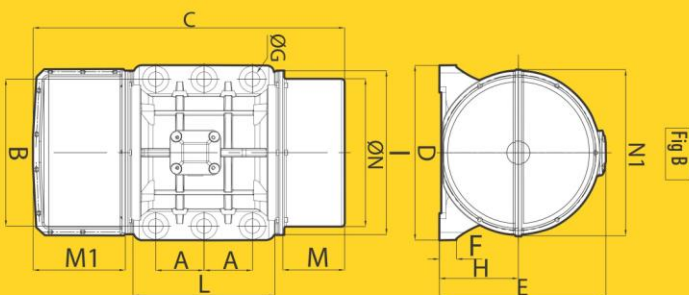

MVE-S with Split Cover

▶ 6 POLES

1000 - 1200 rpm

CE Declaration of conformity "type B" according to:
- 2006/95/EC - 2004/108/EC - 2006/42/EC - EN 60034-1

TYPE	Mechanical Features						Electric Features							
	Working moment (*)		FC		Weight		Power		Current		Ia/In		Ex	Cable Glande
	Kgcm		Kg		Kg		Kw		A max (Y)				II3 D	
	50Hz	60Hz	50Hz	60Hz	50Hz	60Hz	50 Hz	60 Hz	50 Hz	60 Hz	50Hz	60Hz	Temp. Class	
								400V	460V			(°C)		
MVE 800/1S	137.37	108.58	767	873	61.8	59.4	0.68	0.76	1.29	1.26	2.80	2.80	135	M25
MVE 1100/1S	187.69	137.31	1048	1104	79.4	73.0	0.75	0.80	1.42	1.32	3.20	3.10	135	M25
MVE 1500/1S	284.76	196.51	1590	1580	83.6	76.5	1.10	1.30	2.10	2.00	3.30	3.30	135	M25
MVE 2600/1S	467.44	306.70	2610	2466	148.6	131.5	1.96	2.10	3.63	3.38	4.80	4.80	135	M32
MVE 3000/1S	540.33	379.71	3017	3053	155.4	137.8	2.20	2.40	4.50	4.30	5.00	5.00	135	M32
MVE 3800/1S	680.38	437.41	3799	3517	215.6	194.8	2.50	3.00	4.67	4.88	5.90	6.00	135	M32
MVE 4700/1S	838.34	584.17	4681	4697	230.8	212.4	3.20	3.90	6.50	6.00	5.50	5.70	135	M32
MVE 5200/1S	929.86	654.57	5192	5263	279.8	264.2	3.80	4.00	6.92	6.36	5.50	5.50	135	M32
MVE 6500/1S	1165.19	823.96	6506	6625	304.4	280.7	4.30	5.00	7.76	7.81	6.20	6.00	135	M32

TYPE	Mechanical Features						Electric Features							
	Working moment (*)		FC		Weight		Power		Current		Ia/In		Ex	Cable Glande
	Kgcm		Kg		Kg		Kw		A max (Δ)				II3 D	
	50Hz	60Hz	50Hz	60Hz	50Hz	60Hz	50 Hz	60 Hz	50 Hz	60 Hz	50Hz	60Hz	Temp. Class	
								400V	460V			(°C)		
MVE 8000/1S	1435.98	929.80	8018	7476	325	290	7.10	7.50	12.60	11.60	6.00	6.20	135	M32
MVE 9000/1S	1600.39	1165.23	8936	9369	338	308	7.50	8.30	13.20	12.60	6.30	6.20	135	M32
MVE 10000/1S	1788.44	1239.98	9986	9970	386	359	7.60	8.00	13.50	12.70	6.40	6.40	135	M32

(*) = Working moment = 2 x static moment

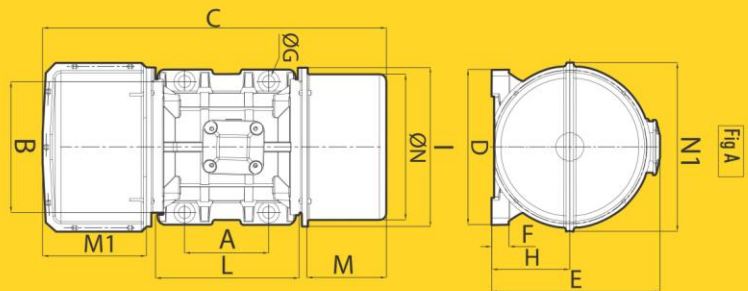
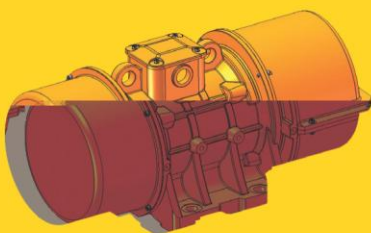

- Ex - II3 D Ex tD A22 Tx IP66
- TUV NORD Statement Conformity Number TUV 05 ATEX 2768X
- Equipment and protective system intended for use in potentially explosive atmospheres (Zone 22) - Directive 94/9/EC
- Compliance with Essential Health and Safety Requirements
- EN 61241-10



Dimensional Features																		
FIG.	Size	C (mm)		M (mm)		M1 (mm)	A (mm)	B (mm)	Ø G (mm)	Holes n°	D (mm)	E (mm)	F (mm)	H (mm)	I (mm)	L (mm)	N (mm)	N1 (mm)
		50Hz	60Hz	50Hz	60Hz	50Hz - 60Hz												
A	60	538		98		188	140	190	17	4	229	247	30	120	245	220	222	272
A	60	569	538	129	98	188	140	190	17	4	229	247	30	120	245	220	222	272
A	60	596	569	188	128	188	140	190	17	4	229	247	30	120	235	220	222	272
A	75	737		200		228	155	255	23.5	4	302	318	35	147	295	273	265	315
A	75	737		200		228	155	255	23.5	4	302	318	35	147	295	273	265	315
A	80	683	695	170	130	222	180	280	26	4	332	360	37	167	340	304	310	361
A	80	760	683	195	170	222	180	280	26	4	332	360	37	167	340	304	310	361
A	85	770	723	160	120	238	200	320	28	4	378	410	50	200	420	325	378	430
A	85	763	770	160		238	200	320	28	4	378	410	50	200	420	325	378	430

Dimensional Features																		
FIG.	Size	C (mm)		M (mm)		M1 (mm)	A (mm)	B (mm)	Ø G (mm)	Holes n°	D (mm)	E (mm)	F (mm)	H (mm)	I (mm)	L (mm)	N (mm)	N1 (mm)
		50Hz	60Hz	50Hz	60Hz	50Hz - 60Hz												
A	85	785	770	210	160	238	200	320	28	4	378	410	50	200	420	325	378	430
A	85	785	763	210	160	238	200	320	28	4	378	410	50	200	420	325	378	430
B	90	854		854		238	125	380	38	6	452	430	44	204	424	367	378	430

NOTE: Dimensions with coarse degree of accuracy related to UNI 22768/1

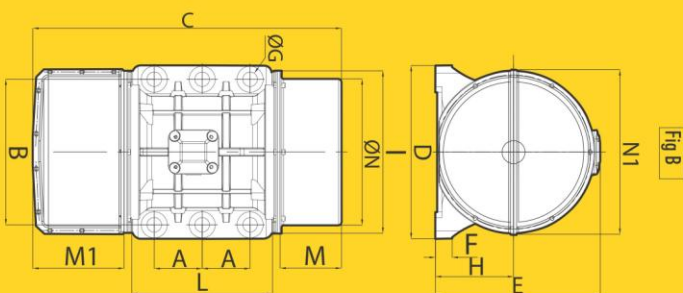

MVE-S with Split Cover

► 8 POLES

850 - 900 rpm

CE Declaration of conformity "type B" according to:
- 2006/95/EC - 2004/108/EC - 2006/42/EC - EN 60034-1

TYPE	Mechanical Features				Electric Features							
	Working moment (*) KgcM 50Hz - 60Hz	FC Kg		Weight Kg 50Hz - 60Hz	Power Kw		Current A max (Y)		Ia/In		Ex	Cable Glande Class Temp
		50Hz	60Hz		50 Hz	60 Hz	50 Hz	60 Hz	50Hz	60Hz	II 3 D	
MVE 650/075S	137.31	431	621	64.7	0.50	0.60	1.20	1.20	2.20	2.20	135	M25
MVE 900/075S	187.72	589	849	71.0	0.65	0.78	1.23	1.29	2.50	2.50	135	M25
MVE 2100/075S	467.41	1468	2114	150.4	1.50	1.80	2.81	2.89	4.20	4.10	135	M32
MVE 3100/075S	680.34	2137	3077	212.2	2.00	2.30	3.79	3.77	4.00	4.00	135	M32
MVE 3800/075S	838.43	2633	3792	230.2	2.50	3.00	6.00	6.00	3.90	4.00	135	M32
MVE 4200/075S	929.74	2920	4205	284.5	2.90	3.40	6.50	6.50	3.80	3.70	135	M32
MVE 5300/075S	1165.22	3660	5270	305	4.00	4.30	8.50	8.00	3.80	4.20	135	M32
MVE 6500/075S	1435.85	4510	6494	324.4	5.00	5.90	10.00	10.00	3.60	4.00	135	M32

(*) = Working moment = 2 x static moment

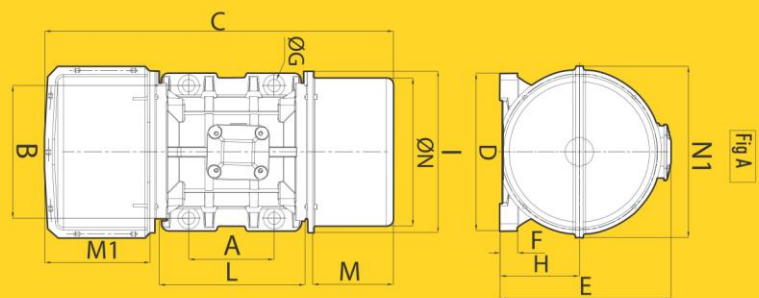
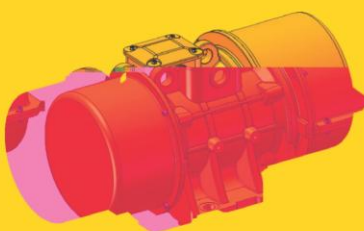

- Ex - II3 D Ex tD A22 Tx IP66
- TUV NORD Statement Conformity Number TUV 05 ATEX 2768X
- Equipment and protective system intended for use in potentially explosive atmospheres (Zone 22) - Directive 94/9/EC
- Compliance with Essential Health and Safety Requirements
- EN 61241-10



TYPE	Dimensional Features																
	FIG.	Size	C	M	M1	A	B	Ø G	Holes	D	E	F	H	I	L	N	N1
			(mm) 50Hz - 60Hz	(mm) 50Hz - 60Hz	(mm) 50Hz - 60Hz	(mm)	(mm)	(mm)	n°	(mm)	(mm)	(mm)	(mm)	(mm)	(mm)	(mm)	(mm)
MVE 650/075S	A	60	569	128	188	140	190	17	4	229	247	30	120	245	220	222	272
MVE 900/075S	A	60	569	128	188	140	190	17	4	229	247	30	120	245	220	222	272
MVE 2100/075S	A	75	737	200	228	155	255	23.5	4	302	318	35	147	295	273	265	315
MVE 3100/075S	A	80	683	170	222	180	280	26	4	332	360	37	167	340	304	310	361
MVE 3800/075S	A	80	760	195	222	180	280	26	4	332	360	37	167	340	304	310	361
MVE 4200/075S	A	85	770	160	238	200	320	28	4	378	410	50	200	420	325	378	420
MVE 5300/075S	A	85	763	160	238	200	320	28	4	378	410	50	200	420	325	378	420
MVE 6500/075S	A	85	785	210	238	200	320	28	4	378	410	50	200	420	325	378	420

NOTE: Dimensions with coarse degree of accuracy related to UNI 22768/1

